

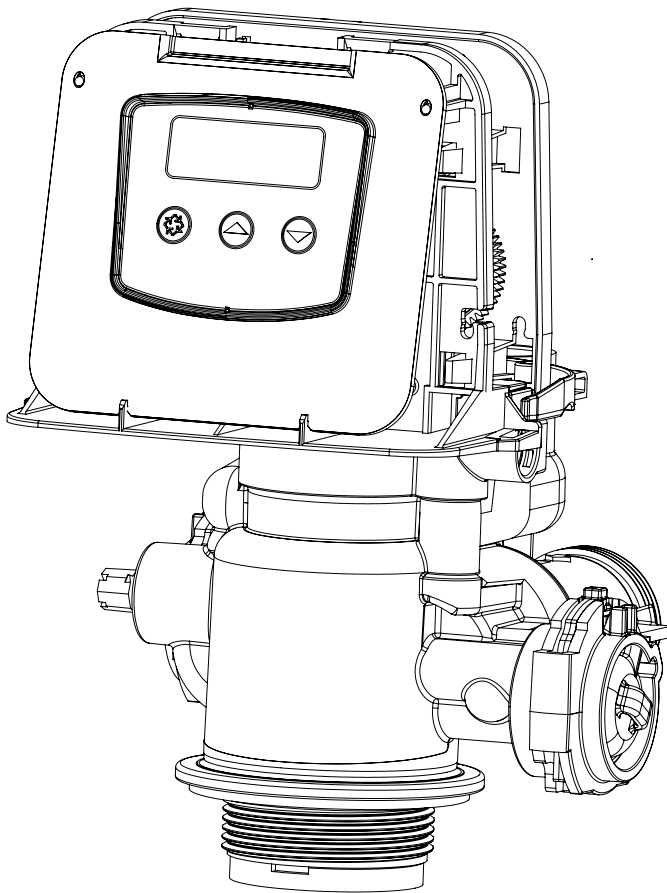

FLECK 5810 & 5812 SXT
WATER SOFTENER OR FILTER CONTROL VALVE
SERVICE MANUAL

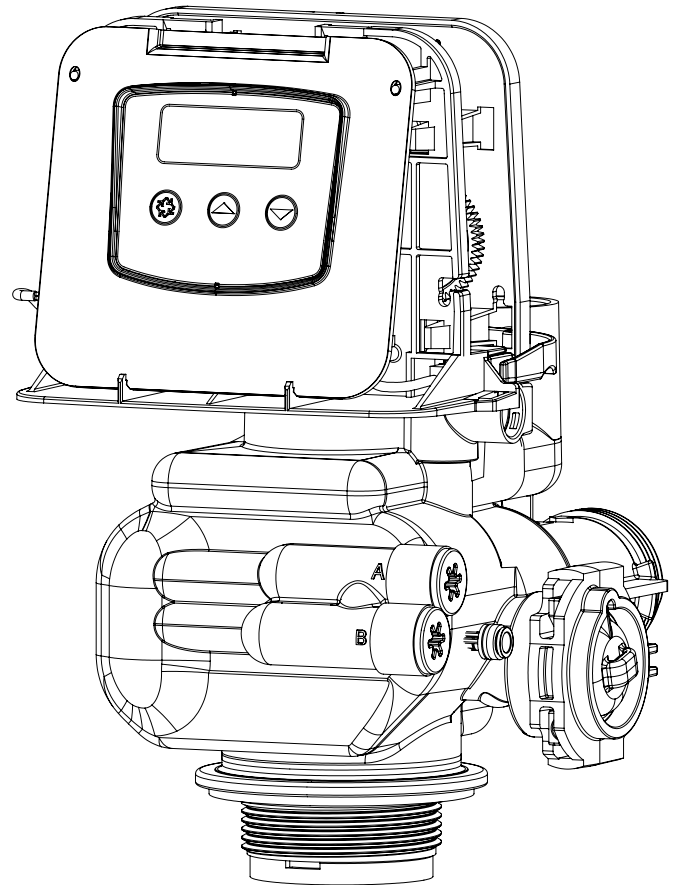

5810



5812

TABLE OF CONTENTS

JOB SPECIFICATION SHEET	3
OPERATING PARAMETERS	3
INSTALLATION	4
START-UP INSTRUCTIONS/FLUSHING & CONDITIONING	5
CONTROL FEATURES	5
USER PROGRAMMING	6
SYSTEM DISINFECTION	7
INSTALLATION CHECKLIST	7
CARE AND USE OF YOUR BRINE TANK	7
CONTROL OPERATION	8
MASTER PROGRAMMING MODE CHART	9
MASTER PROGRAMMING MODE	10
VIEWING DIAGNOSTIC DATA	14
5810 CONTROL VALVE ASSEMBLY	16
5812 CONTROL VALVE ASSEMBLY	17
5810/5812 VALVE ACCESSORIES	18
5810/5812 VALVE ASSEMBLIES	19
SAFETY BRINE VALVE	20
TROUBLESHOOTING	21
WATER CONDITIONER FLOW DIAGRAMS	22
5810 DIMENSIONAL DRAWINGS	26
5812 DIMENSIONAL DRAWINGS	27
SXT WIRING DIAGRAM	28
INJECTOR FLOW DATA	29
TYPICAL RESIDENTIAL SYSTEM PLUMBING	30
TRANSFORMER PORT LOCATION	31

JOB SPECIFICATION SHEET

Job Number: _____
Model Number: _____
Water Hardness: _____ ppm or gpg
Capacity Per Unit: _____
Mineral Tank Size: _____ Diameter: _____ Height: _____
Salt Setting per Regeneration: _____
Regenerant Flow: Upflow Downflow

1. Meter Size:

A. 1-1/4" Turbine

2. System Type:

A. System #4: 1 Tank, 1 Meter, Immediate, or Delayed Regeneration

B. System #4: Time Clock

3. Control Program Settings:

A. Backwash: _____ Minutes

B. Brine and Slow Rinse: _____ Minutes

C. Rapid Rinse: _____ Minutes

D. Brine Tank Refill: _____ Minutes

E. Pause Time: _____ Minutes

F. Second Backwash: _____ Minutes

4. Drain Line Flow Control: _____ gpm

5. Brine Line Flow Control: _____ gpm

6. Injector Size#: _____

IMPORTANT PLEASE READ:

- The information, specifications and illustrations in this manual are based on the latest information available at the time of release. The manufacturer reserves the right to make changes at any time without notice.
- This manual is intended as a guide for service of the valve only. System installation requires information from a number of suppliers not known at the time of manufacture. This product should be installed by a plumbing professional.
- This product must be installed in compliance with all state and municipal plumbing and electrical codes. Permits may be required at the time of installation.
- It is established that when daytime water pressure exceeds 80 psi (5.5 bar), the maximum pressure rating of 125 psi (8.6 bar) can be exceeded. A pressure regulator must be installed on this system or warranty is voided.
- Do not install the unit where temperatures may drop below 32°F (0°C) or above 120°F (52°C).
- Do not place the unit in direct sunlight. Black units will absorb radiant heat increasing internal temperatures.
- Do not strike the valve or any of the components.
- Warranty of this product extends to manufacturing defects. Misapplication of this product may result in failure to properly condition water, damage to product, or personal injury.
- A prefilter should be used on installations in which free solids are present.
- In some applications local municipalities treat water with Chloramines. High Chloramine levels may damage valve components.
- Correct and constant voltage must be supplied to the controller to maintain proper function.
- The system is intended to treat only potable quality water. It is not intended as the permanent primary treatment of water from a source that is contaminated, such as from radon, pesticides, insecticides, sewage or wastewater.
- This system is not intended for use by persons (including children) with reduced physical, sensory, or mental capabilities, or lack of experience and knowledge, unless they have been given supervision or instruction concerning use of the appliance by a person responsible for their safety.
- Children shall not play with the system.
- Cleaning shall not be made by children without supervision.
- Periodic cleaning and maintenance may be required to function properly. See disinfection instructions on page 7.

OPERATING PARAMETERS

Minimum Pressure 20 psi/1.4 bar/138 kPa

Maximum Pressure 125 psi/8.61 bar/861 kPa

Minimum Water Temperature 34°F/1°C

Maximum Water Temperature 110°F/43°C

Minimum Ambient Temperature 34°F/1°C

Maximum Ambient Temperature 120°F/52°C

Maximum Humidity 75%

Input Voltage 100-240 VAC

Input Frequency 50/60 Hz

Output Voltage 12 VDC

Output Current 2.0 amps

Maximum Altitude 2,000 meters



The 5810 & 5812 models are Tested and Certified by the WQA to NSF/ANSI Std. 44 & 372 for material safety and structural integrity & lead free compliance and CSA B483.1.

Component

CALIFORNIA PROPOSITION 65 WARNING

⚠ WARNING: This product contains chemicals known to the State of California to cause cancer or birth defects or other reproductive harm.

INSTALLATION

Water Pressure

A minimum of 20 psi (1.4 bar) of water pressure is required for the regeneration valve to operate effectively.

Electrical Facilities

An uninterrupted alternating current (120 VAC) supply is required. The control uses a transformer to supply 12 VDC. Please make sure your voltage supply is compatible with your unit before installation.

Existing Plumbing

Condition of existing plumbing should be free from lime and iron buildup. Piping that is built up heavily with lime and/or iron should be replaced. If piping is clogged with iron, a separate iron filter unit should be installed ahead of the water softener.

Location of Softener and Drain

You must have an air gap on the drain line to prevent back flow of drain water into the system. A 2x the drain line pipe diameter air gap is required with a minimum 1" air gap.

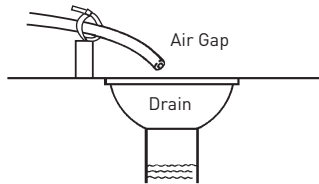

Figure 1 Air Gap

Installation Locations

FOR DRY LOCATIONS ONLY.

Bypass Valves

Always provide for the installation of a bypass valve if unit is not equipped with one.

CAUTION Water pressure is not to exceed 125 psi (8.6 bar), water temperature is not to exceed 110°F (43°C), and the unit cannot be subjected to freezing conditions.

WARNING: The system must be depressurized before removing any connections for servicing.

Installation Instructions

1. Place the softener tank where you want to install the unit. Make sure the unit is level and on a firm base.
2. During cold weather, the installer should warm the valve to room temperature before operating.
3. All plumbing should be done in accordance with local plumbing codes. The pipe size for a residential drain line should be a minimum of 1/2" (13 mm). Backwash flow rates in excess of 7 gpm (26.5 Lpm) or drain line length in excess of 20' (6 m) require 3/4" (19 mm) drain line. Commercial drain lines should be the same size as the drain line flow control.

NOTE: The tank should have the distributor tube installed and have the proper amount of regenerant in place.

4. Refer to the spec sheet for cutting height of the distributor tube.
5. Lubricate the distributor O-ring seal and tank O-ring seal. Place the main control valve on tank. Note: Only use silicone lubricant.

6. Soldering of joints near the drain port must be done prior to connecting the Drain Line Flow Control fitting (DLFC). Leave at least 6" (15 cm) between the DLFC and solder joints when soldering pipes that are connected on the DLFC. Failure to do this could cause interior damage to the DLFC.
7. PTFE plumbing tape is the only sealant to be used on the drain fitting.
8. Make sure that the floor is clean beneath the salt storage tank and that the tank is level.
9. Place approximately 1" (25 mm) of water above the grid plate. If a grid is not utilized, fill to the top of the air check (Figure 1) in the salt tank. Do not add salt to the brine tank at this time.

CAUTION If grid plate is used, cut air check height even with grid plate. This is critical on 6", 7", 8" and 9" tanks. The brine refill water must come above the grid plate and make contact with the salt.

10. On units with a bypass, place in bypass position. Turn on the main water supply. Open a cold soft water tap nearby and let run a few minutes or until the plumbing is free from foreign material (usually solder) that may have resulted from the installation. Once clean, close the water tap.
11. Slowly place the bypass in service position and let water flow into the mineral tank. When water flow stops, slowly open a cold water tap nearby and let water run until the air is purged from the plumbing lines.
12. Plug the transformer into an electrical outlet.

NOTE: All electrical connections must be connected according to local codes. Be certain the outlet is uninterrupted.

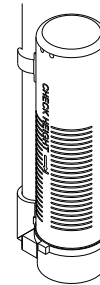

60002 Rev E

Figure 2 Residential Air Check Valve

Electrical Connection

The controller operates on 12-volt DC power supply. Do not operate the controller with a power supply other than the one supplied by the manufacturer for this model. For installation assistance, see Transformer Port Location on page 31.

NOTE: The power source should be constant. Be certain the power adapter is not on a switched outlet. Power interruptions longer than 8 hours may cause the controller to lose the time setting. When power is restored, the time setting must then be re-entered.

START-UP INSTRUCTIONS/ FLUSHING & CONDITIONING

The water softener should be installed with the inlet, outlet, and drain connections made in accordance with the manufacturer's recommendations, and to meet applicable plumbing codes.

1. Program the valve control according to instructions shown in this manual.
2. Start an immediate regeneration by holding the Extra Cycle button for five seconds. Position the valve to backwash. Ensure the drain line flow remains steady for 10 minutes or until the water runs clear.
3. Position the valve to the brine draw / slow rinse position. Ensure the unit is drawing water from the brine tank (this step may need to be repeated).
4. Position the valve to the rapid rinse position. Check the drain line flow, and run for five minutes or until the water runs clear.
5. Position the valve to the start of the brine tank fill cycle. Ensure water goes into the brine tank at the desired rate. The brine valve drive cam will hold the valve in this position to fill the brine tank for the first regeneration.
6. Replace control cover.
7. Put salt in the brine tank.

NOTE: Do not use granulated or rock salt.

CONTROL FEATURES

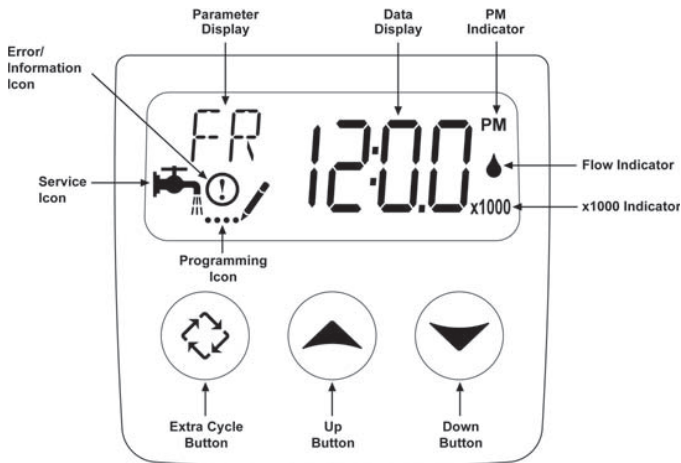

Figure 3

Features of the SXT:

- Power backup that continues to keep time and the passage of days for a minimum of 8 hours in the event of power failure. During a power outage, the control goes into a power-saving mode. It does not monitor water usage during a power failure, but it does store the volume remaining at the time of power failure.
- Settings for both valve (basic system) and control type (method used to trigger a regeneration).
- Day-of-the-Week controls.
- While in service, the display alternates between time of day, volume remaining or days to regeneration.
- The Flow Indicator flashes when outlet flow is detected.
- The Service Icon flashes if a regeneration cycle has been queued.
- A Regeneration can be triggered immediately by pressing the Extra Cycle button for five seconds.

- The Parameter Display displays the current cycle step (BW, BF, RR etc) during regeneration, and the data display counts down the time remaining for that cycle step. While the valve is transferring to a new cycle step, the display will flash. The parameter display will identify the destination cycle step (BW, BF, RR, etc.) and the data display will read "-----". Once the valve reaches the cycle step, the display will stop flashing and the data display will change to the time remaining. During regeneration, the user can force the control to advance to the next cycle step immediately by pressing the Extra Cycle button.

Setting the Time of Day

1. Press and hold either the Up or Down buttons until the programming icon replaces the service icon and the parameter display reads TD.
2. Adjust the displayed time with the Up and Down buttons.
3. When the desired time is set, press the Extra Cycle button to resume normal operation. The unit will also return to normal operation after five seconds if no buttons are pressed.

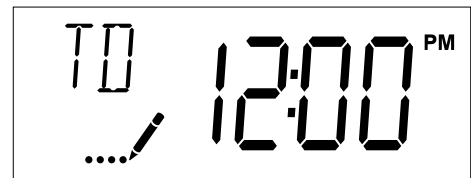

Figure 4

Queuing a Regeneration

1. Press the Extra Cycle button. The service icon will flash to indicate that a regeneration is queued.
2. To cancel a queued regeneration, press the Extra Cycle button.

Regenerating Immediately

Press and hold the Extra Cycle button for five seconds.

USER PROGRAMMING

The 5800 SXT control was designed to operate under most conditions with minimal programming. Follow the procedure below to set up the control for normal operation. For more in-depth programming information, see the Master Programming section.

Abbreviation	Parameter	Description
DO	Day Override	The control's day override setting.
RT	Regeneration Time	The time of the day that the system will regenerate (meter delayed, time clock, and day-of-week systems)
H	Feed Water Hardness	The hardness of the inlet water - used to calculate system capacity for metered systems.
RC or SF	Reserve Capacity or Safety Factor	The fixed reserve capacity of the system in gallons to maintain before the next scheduled regeneration. Can also be set as a percentage of total capacity. See Master Programming section..
CD	Current Day	The current day of week.

NOTE: Some items may not be shown depending on control configuration. The control will discard any changes and exit User Programming Mode if a button is not pressed for 60 seconds.

NOTE: When variable reserve (cr) is selected from Master Programming, User Programming will display SF. However, changing the value of SF will have no effect when variable reserve is selected in Master Programming.

User Programming Mode Steps

1. Press the Up and Down buttons for five seconds while in service, and the time of day is NOT set to 12:01 PM.
2. Use this display to adjust the Day Override. This option setting is identified by "DO" in the upper left corner of the screen.

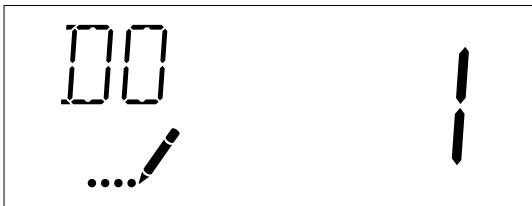

Figure 5

3. Press the Extra Cycle button. Use this display to adjust the Regeneration Time. This option setting is identified by "RT" in the upper left corner of the screen.

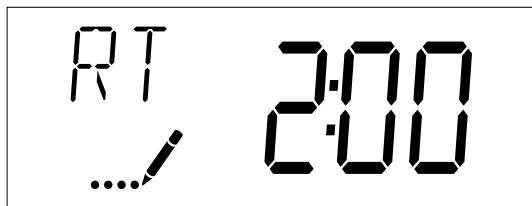

Figure 6

4. Press the Extra Cycle button. Use this display to adjust the Feed Water Hardness. This option setting is identified by "H" in the upper left corner of the screen.

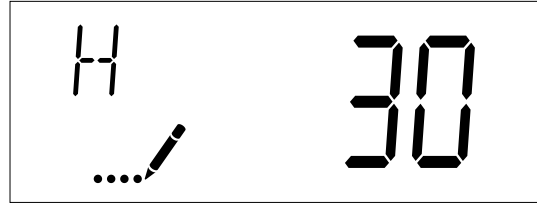

Figure 7

Range: 1-199 hardness

5. Press the Extra Cycle button. Use this display to adjust the Fixed Reserve Capacity. This option setting is identified by "RC" or "SF" in the upper left corner of the screen.

NOTE: This setting is dependent upon Reserve Selection setting in Master Programming. Default is RC - Reserve Capacity (Gallons). See Master Programming section for more information.

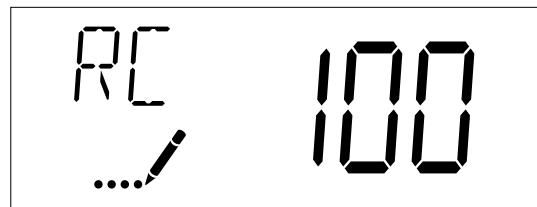

Figure 8

6. Press the Extra Cycle button. Use this display to set the Current Day of the Week. This option setting is identified by "CD" in the upper left corner of the screen.



Figure 9

7. Press the Extra Cycle button to end User Programming.

SYSTEM DISINFECTION

Disinfection Of Water Softeners

The materials of construction of the modern water softener will not support bacterial growth, nor will these materials contaminate a water supply. During normal use, a softener may become fouled with organic matter, or in some cases with bacteria from the water supply. This may result in an off-taste or odor in the water.

Some softeners may need to be disinfected after installation and some softeners will require periodic disinfection during their normal life.

Depending upon the conditions of use, the style of softener, the type of ion exchanger, and the disinfectant available, a choice can be made among the following methods.

Sodium or Calcium Hypochlorite

Application

These materials are satisfactory for use with polystyrene resins, synthetic gel zeolite, greensand and bentonites.

5.25% Sodium Hypochlorite

These solutions are available under trade names such as Clorox*. If stronger solutions are used, such as those sold for commercial laundries, adjust the dosage accordingly.

1. Dosage
 - A. Polystyrene resin; 1.2 fluid ounce (35.5 ml) per cubic foot.
 - B. Non-resinous exchangers; 0.8 fluid ounce (23.7 ml) per cubic foot.
2. Salt tank softeners
 - A. Backwash the softener and add the required amount of hypochlorite solution to the well of the salt tank. The salt tank should have water in it to permit the solution to be carried into the softener.
 - B. Proceed with the normal recharge.

*Clorox is a trademark of the Clorox Company.

Calcium Hypochlorite

Calcium hypochlorite, 70% available chlorine, is available in several forms including tablets and granules. These solid materials may be used directly without dissolving before use.

1. Dosage
 - A. Two grains (approximately 0.1 ounce [3 ml]) per cubic foot.
2. Salt tank softeners
 - A. Backwash the softener and add the required amount of hypochlorite to the well of the salt tank. The salt tank should have water in it to permit the chlorine solution to be carried into the softener.
 - B. Proceed with the normal recharge.

INSTALLATION CHECKLIST

- Read the owner's/installation manual?
- Follow all safety guidelines in the manual?
- If metal pipe was used, did you restore the electrical ground?
- Securely install both drain hoses to an approved drain?
- Perform a leak test?
- Move the bypass valve to service?
- Sanitize the softener?
- Add salt pellets to the salt storage tank?
- Program the control correctly to meet your needs?
- Start a regeneration?

CARE AND USE OF YOUR BRINE TANK

Each time the softener regenerate, salty water (brine) is needed to recondition the media in the water tank. The brine is pulled from the salt tank at a controlled amount. If the salt tank does not contain enough salt, the brine is weak, the media will not fully recondition and untreated water will pass through.

You must keep salt in the tank.

The salt tank operates best when the salt level is below half-full. If the tank is filled more than that the salt pellets may "bridge". The salt pellets wedge against each other and do not fall into the water at the bottom. Bridging will eventually provide no salt to make brine. The softener will regenerate but not recondition the media. A salt bridge can be broken up using a broom handle or similar rod. Carefully pound it into the salt and the pellets will collapse. After loosening the salt pellets wait 2 hours and start a regeneration. A second regenerate may be needed to fully recondition the media.

You should only use sodium chloride pellet salt for water softeners. Other types of salt (rock or snow melting) will contain dirt and chemicals that will affect your water softener. Keep the brine tank covered.

Empty and clean the tank every three years.

CONTROL OPERATION

Meter Immediate Control

A Meter Immediate control measures water usage and regenerates the system as soon as the calculated system capacity is depleted. The control calculates the system capacity by dividing the unit capacity (typically expressed in grains/unit volume) by the feed water hardness and subtracting the reserve. Meter Immediate systems generally do not use a reserve volume. The control will also start a regeneration cycle at the programmed regeneration time if a number of days equal to the regeneration day override pass before water usage depletes the calculated system capacity.

Meter Delayed Control

A Meter Delayed Control measures water usage. The system regenerates at the programmed regeneration time after the calculated system capacity is depleted. As with Meter Immediate systems, the control calculates the system capacity by dividing the unit capacity by the feed water hardness and subtracting the reserve. The reserve should be set to ensure that the system delivers treated water between the time the system capacity is depleted and the actual regeneration time. A Meter Delayed control will also start a regeneration cycle at the programmed regeneration time if a number of days equal to the regeneration day override pass before water usage depletes the calculated system capacity.

Time Clock Delayed Control

A Time Clock Delayed Control regenerates the system on a timed interval. The control will initiate a regeneration cycle at the programmed regeneration time when the number of days since the last regeneration equals the regeneration day override value.

Day of the Week Control

This control regenerates the system on a weekly schedule. The schedule is defined in Master Programming by setting each day to either "off" or "on". The control will initiate a regeneration cycle on days that have been set to "on" at the specified regeneration time.

Control Operation During Regeneration

During regeneration, the control shows the current regeneration step number the valve is advancing to, or has reached, and the time remaining in that step. The step number that displays flashes until the valve completes driving to this regeneration step position. Once all regeneration steps are complete the valve returns to service and resumes normal operation.

Pressing the Extra Cycle button during a regeneration cycle immediately advances the valve to the next cycle step position and resumes normal step timing.

Control Operation During Programming

The control only enters the Program Mode with the valve in service. While in the Program Mode, the control continues to operate normally monitoring water usage and keeping all displays up to date. Control programming is stored in memory permanently.

Manually Initiating a Regeneration

1. When the system is in service, press the Extra Cycle button for five seconds on the main screen.
2. The control advances to Regeneration Cycle Step #1 (backwash), and begins programmed time count down.
3. Press the Extra Cycle button once to advance valve to Regeneration Cycle Step #2 (brine draw and slow rinse).
4. Press the Extra Cycle button once to advance valve to Regeneration Cycle Step #3 (rapid rinse).
5. Press the Extra Cycle button once to advance valve to Regeneration Cycle Step #4 (brine refill).
6. Press the Extra Cycle button once more to advance the valve back to in service.

NOTE: If the unit above is for standard downflow single backwash only, if not this unit the cycle step order may change.

NOTE: A queued regeneration can be initiated by pressing the Extra Cycle button. To clear a queued regeneration, press the Extra Cycle button again to cancel. If regeneration occurs for any reason prior to the delayed regeneration time, the manual regeneration request will be cleared.

Control Operation During a Power Failure

The SXT includes integral power backup. In the event of power failure, the control shifts into a power-saving mode. The control stops monitoring water usage. The display and motor shut down, but it continues to keep track of the time and day for a minimum of 8 hours.

The system configuration settings are stored in a non-volatile memory and are stored indefinitely with or without power. The Time of Day flashes when there has been a power failure. Press any button to stop the Time of Day from flashing.

If power fails while the unit is in regeneration, the control will save the current valve position before it shuts down. When power is restored, the control will resume the regeneration cycle from the point where power failed.

CAUTION If power fails during a regeneration cycle, the valve will remain in its current position until power is restored. The valve system should include all required safety components to prevent overflows resulting from a power failure during regeneration.

The control will not start a new regeneration cycle without power. If the valve misses a scheduled regeneration due to a power failure, it will queue a regeneration. Once power is restored, the control will initiate a regeneration cycle the next time that the Time of Day equals the programmed regeneration time. Typically, this means that the valve will regenerate one day after it was originally scheduled. If the treated water output is important and power interruptions are expected, the system should be set up with a sufficient reserve capacity to compensate for regeneration delays.

MASTER PROGRAMMING MODE CHART

CAUTION Before entering Master Programming, please contact your local professional water dealer. To enter Master Programming, set time to 12:01 PM.

Master Programming Options			
Abbreviation	Parameter	Option Abbreviation	Options
DF	Display Format	GAL	Gallons
		Ltr	Liters
VT	Valve Type	dF1b	Downflow/Upflow Single Backwash
		dF2b	Downflow Double Backwash
		Fltr	Filter
		UFbd	Upflow Brine Draw First
		Othr	Other
CT	Control Type	Fd	Meter (Flow) Delayed
		FI	Meter (Flow) Immediate
		tc	Time Clock
		dAY	Day of Week
NT	Number of Tanks	1	Single Tank System
		2	Two Tank System
TS	Tank in Service	U1	Tank 1 in Service
		U2	Tank 2 in Service
C	Unit Capacity		Unit Capacity (Grains)
H	Feedwater Hardness		Hardness of Inlet Water
RS	Reserve Selection	SF	Percentage Safety Factor
		rc	Fixed Reserve Capacity
		cr	Variable Reserve Capacity
SF	Safety Factor		Percentage of the system capacity to be used as a reserve
RC	Fixed Reserve Capacity		Fixed volume to be used as a reserve
DO	Day Override		The system's day override setting
RT	Regen Time		The time of day the system will regenerate
BW, BD, RR, BF	Regen Cycle Step Times		The time duration for each regeneration step. Adjustable from OFF and 0-199 minutes. If "Othr" is chosen under "Valve Type", then R1, R2, R3, etc, will be displayed instead
D1, D2, D3, D4, D5, D6, & D7	Day of Week Settings		Regeneration setting (On or OFF) for each day of the week on day-of-week systems
CD	Current Day		The Current day of the week
FM	Flow Meter Type	P0.7	3/4" Paddle Wheel Meter
		Gen	Generic or Other Meter
		P2.0	2" Paddle Wheel Meter
		t1.5	1.5" Turbine Meter
		P1.5	1.5" Paddle Wheel Meter
		t1.2	1.25" Turbine Wheel Meter
		t1.0	1" Turbine Meter
		P1.0	1" Paddle Wheel Meter
t0.7	3/4" Turbine Meter		
K	Meter Pulse Setting		Meter pulses per gallon for generic/other flow meter

Some items may not be shown depending on timer configuration. The timer will discard any changes and exit Master Programming Mode if any button is not pressed for sixty seconds.

MASTER PROGRAMMING MODE

When Master Programming Mode is entered, all available option setting displays may be viewed and set as needed. Depending on current option settings, some parameters cannot be viewed or set.

Setting the Time of Day

1. Press and hold either the Up or Down buttons until the programming icon replaces the service icon and the parameter display reads TD.
2. Adjust the displayed time with the Up and Down buttons.
3. When the desired time is set, press the Extra Cycle button to resume normal operation. The unit will also return to normal operation after five seconds if no buttons are pressed.



Figure 10

Entering Master Programming Mode

Set the Time of Day display to 12:01 P. M. Press the Extra Cycle button (to exit Setting Time of Day mode). Then press and hold the Up and Down buttons together until the programming icon replaces the service icon and the display format screen appears.

Exiting Master Programming Mode

Press the Extra Cycle button to accept the displayed settings and cycle to the next parameter. Press the Extra Cycle button at the last parameter to save all settings and return to normal operation. The control will automatically disregard any programming changes and return to normal operation if it is left in Master Programming mode for 5 minutes without any keypad input.

Resets

Soft Reset

Press and hold the Extra Cycle and Down buttons for 25 seconds while in normal Service mode. This resets all parameters to the system default values. Not reset are the volume remaining in meter immediate or meter delayed systems and days since regeneration in the time clock system.

Master Reset

Hold the Extra Cycle button while powering up the unit. This resets all of the parameters in the unit back to factory defaults. Check and verify the choices selected in Master Programming Mode.

1. Display Format (Display Code DF)

This is the first screen that appears when entering Master Programming Mode. The Display Format setting specifies the unit of measure that will be used for volume and how the control will display the Time of Day. This option setting is identified by "DF" in the upper left corner of the screen. There are two possible settings.

Display Format Setting	Unit of Volume	Time Display
GAL	U.S. Gallons	12-Hour AM/PM
Ltr	Liters	24-Hour



Figure 11

2. Valve Type (Display Code VT)

Press the Extra Cycle button. Use the display to set the Valve Type.

3. Regenerant Flow (Display Code RF)

Press the Extra Cycle button. The Regenerant Flow Setting specifies the type of cycle that the valve follows during regeneration. Note that some valve configurations are built with specific subcomponents. Ensure the valve is configured properly before changing the Regenerant Flow setting. This option setting is identified by "RF" in the upper left corner of the screen. There are eight possible settings.

Abbreviation	Parameter
dF1b	Standard Downflow Single Backwash
dF2b	Standard Downflow Double Backwash
Fltr	Filter
dFFF	Downflow Fill First
UFbd	Upflow Brine Draw First
UFFF	Upflow Brine Fill First
O-dF	Other Downflow
O-UF	Other Upflow

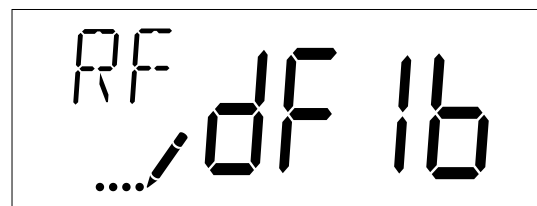

Figure 12

4. Control Type (Display Code CT)

Press the Extra Cycle button. Use this display to set the Control Type. This specifies how the control determines when to trigger a regeneration. For details on how the various options function, refer to the Control Operation section of this service manual. This option setting is identified by "CT" in the upper left corner of the screen. There are four possible settings.

Abbreviation	Parameter
Fd	Meter (Flow) Delayed
FI	Meter (Flow) Immediate
tc	Time Clock
dAY	Day of Week

MASTER PROGRAMMING MODE *continued*

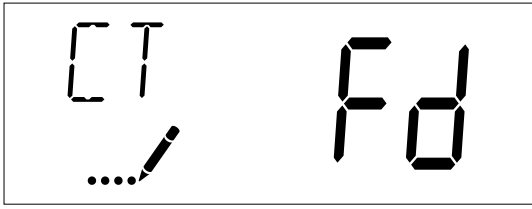

Figure 13

5. Unit Capacity (Display Code C)

Press the Extra Cycle button. Use this display to set the Unit Capacity. This setting specifies the treatment capacity of the system media. Enter the capacity of the media bed in grains of hardness when configuring a softener system, or desired volume capacity when configuring a filter system. This option setting is identified by "C" in the upper left corner of the screen (or by "V" if volume capacity for a filter). The Unit Capacity parameter is only available if the control type has been set to one of the metered options. Use the Up and Down buttons to adjust the value as needed.



Figure 14

Range: 1-999.9 x 1000 grains/gallon (mg/liter)

6. Feed Water Hardness (Display Code H)

Press the Extra Cycle button. Use this display to set the Feed Water Hardness. Enter the feed water hardness in grains per gallon or degrees for softener systems. This option setting is identified by "H" in the upper left corner of the screen. The feed water hardness parameter is only available if the control type has been set to one of the metered softener options. Use the Up and Down buttons to adjust the value as needed.

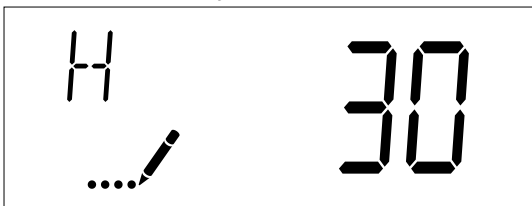

Figure 15

Range: 1-199 grains (degrees)

7. Reserve Selection (Display Code RS)

Press the Extra Cycle button. Use this display to set the Safety Factor and to select the type of reserve to be used in your system. This setting is identified by "RS" in the upper left corner of the screen. The reserve selection parameter is only available if the control type has been set to one of the metered options. There are three possible settings.

Abbreviation	Parameter
SF	Safety Factor
rc	Fixed Reserve Capacity
cr	Variable Reserve

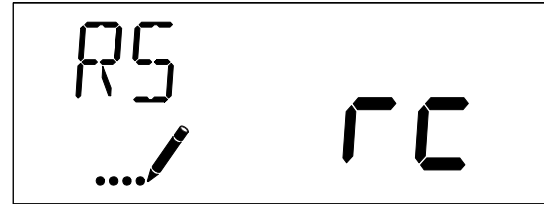

Figure 16

8. Safety Factor (Display Code SF)

Press the Extra Cycle button. Use this display to set the Safety Factor. This setting specifies what percentage of the system capacity will be held as a reserve. Since this value is expressed as a percentage, any change to the unit capacity or feed water hardness that changes the calculated system capacity will result in a corresponding change to the reserve volume. This option setting is identified by "SF" in the upper left corner of the screen. Use the UP and Down buttons to adjust the value from 0 to 50% as needed.

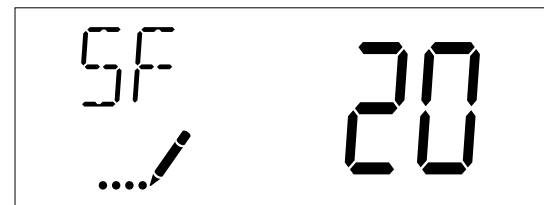

Figure 17

Range: 0-50%

9. Fixed Reserve Capacity (Display Code RC)

Press the Extra Cycle button. Use this display to set the Reserve Capacity. This setting specifies a fixed volume that will be held as a reserve. The reserve capacity cannot be set to a value greater than one-half of the calculated system capacity. The reserve capacity is a fixed volume and does not change if the unit capacity or feed water hardness are changed. This option setting is identified by "RC" in the upper left corner of the screen. Use the Up and Down buttons to adjust the value as needed.

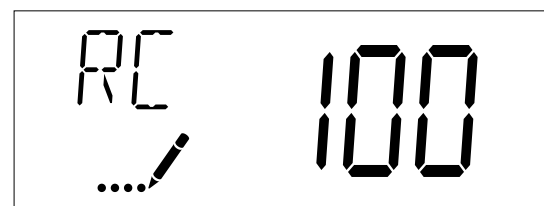

Figure 18

Range: 0-half of the calculated system capacity

MASTER PROGRAMMING MODE *continued*

10. Day Override (Display Code D0)

Press the Extra Cycle button. Use this display to set the Day Override. This setting specifies the maximum number of days between regeneration cycles. If the system is set to a timer-type control, the day override setting determines how often the system will regenerate. A metered system will regenerate regardless of usage if the days since last regeneration cycle equal the day override setting. Setting the day override value to "OFF" disables this function. This option setting is identified by "D0" in the upper left corner of the screen. Use the Up and Down buttons to adjust the value as needed.

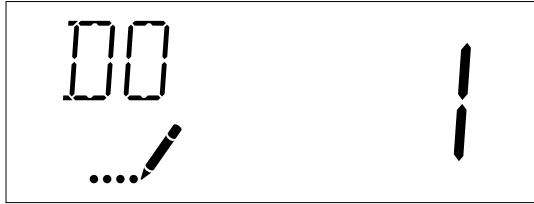

Figure 19

Range: Off-99 days

11. Regeneration Time

Press the Extra Cycle button. Use this display to set the Regeneration Time. This setting specifies the time of day the control will initiate a delayed, manually queued, or day override regeneration. This option setting is identified by "RT" in the upper left corner of the screen. Use the Up and Down buttons to adjust the value as needed.



Figure 20

12. Regeneration Cycle Step Times

Press the Extra Cycle button. Use this display to set the Regeneration Cycle Step Times. The different regeneration cycles are listed in sequence based on the valve type selected for the system, and are identified by an abbreviation in the upper left corner of the screen. The abbreviations used are listed below.

Abbreviation	Cycle Step
BD	Brine Draw
BF	Brine Fill
BW	Backwash
RR	Rapid Rinse
SV	Service

Cycle steps can be programmed in any order using the Up or Down buttons with the following selections. Up to 20 individual cycles can be set. Time for each cycle can be set from 0 to 199 minutes. Setting a cycle step time to 0 will cause the control to skip that step during regeneration, but keeps the following steps available. Use the Up and Down buttons to adjust the value as needed. Press the Extra Cycle button to accept the current setting and move to the next parameter. Program the last cycle step as LC which forces the valve back to the service position.

Abbreviation	Cycle Step
RR	Rapid Rinse
BD	Brine Draw
SR	Slow Rinse
BW	Backwash
RF	Refill
SP	Service Position
LC	Last Cycle

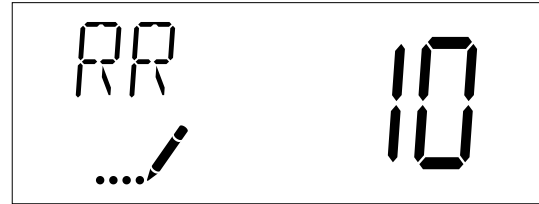

Figure 21

Range: 0-199 minutes

13. Day of Week Settings

Press the Extra Cycle button. Use this display to set the regeneration schedule for a system configured as Day of Week control. The different days of the week are identified as D1, D2, D3, D4, D5, D6, and D7 in the upper left corner of the display. Set the value to "ON" to schedule a regeneration or "OFF" to skip regeneration for each day. Use the Up and Down buttons to adjust the setting as needed. Press the Extra Cycle button to accept the setting and move to the next day. Note that the control requires at least one day to be set to "ON". If all 7 days are set to "Off", the unit will return to Day 1 until one or more days are set to "ON".

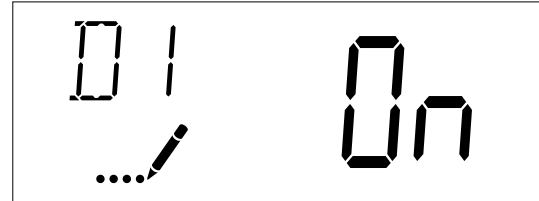

Figure 22

14. Current Day (Display Code CD)

Press the Extra Cycle button. Use this display to set the current day on systems that have been configured as Day of Week controls. This setting is identified by "CD" in the upper left corner of the screen. Use the Up and Down buttons to select from Day 1 through Day 7.



Figure 23

15. Flow Meter Type (Display Code FM)

Press the Extra Cycle button. Use this display to set the type of flow meter connected to the control. This option setting is identified by "FM" in the upper left corner of the screen. Use the Up and Down buttons to select one of the eight available

MASTER PROGRAMMING MODE *continued*

settings.

Abbreviation	Description
P0.7	3/4" Paddle Wheel Meter
t0.7	3/4" Turbine Meter
P1.0	1" Paddle Wheel Meter
t1.0	1" Turbine Meter
P1.5	1.5" Paddle Wheel Meter
t1.5	1.5" Turbine Meter
P2.0	2" Paddle Wheel Meter
Gen	Generic or Other non-Fleck Meter
t1.2	1.25" Turbine Meter

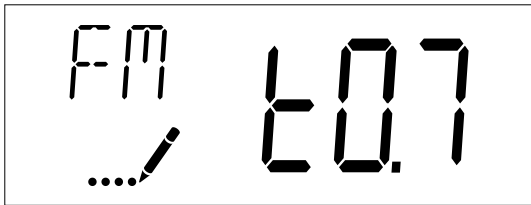

Figure 24

16. Meter Pulse Setting (Display Code K)

Press the Extra Cycle button. Use this display to specify the meter pulse setting for a non-standard flow meter. This option setting is identified by "K" in the upper left corner of the screen. Use the Up and Down buttons to enter the meter constant in pulses per unit volume.



Figure 25

K Range: 0.1 to 999.9 pulses per gallon.

17. Relay Setting (Display Code RE)

Press the Extra Cycle button. Use this display to enable the relay output. This option setting is identified by "RE" in the upper left corner of the screen. Use the Up and Down buttons to enable the relay using **either** time based (tb) or flow based (Fb). **Only one method can be used at a time.**

For time based, set the desired Start Time (ST) and End Time (ET). Time ranges available are determined by the Regen Cycle Step Times. For flow based, set the desired Volume Interval (VO) and Time On (TO).

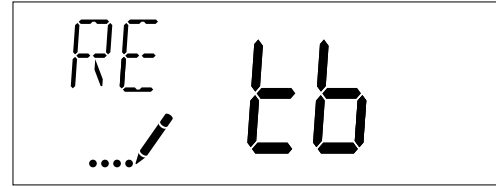

Figure 26

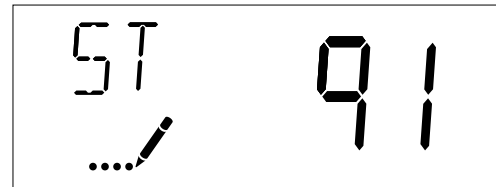

Figure 27

ST Range: 0 to total number of cycles minus 1

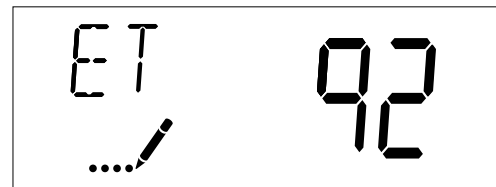

Figure 28

ET Range: Start time to total of all cycles

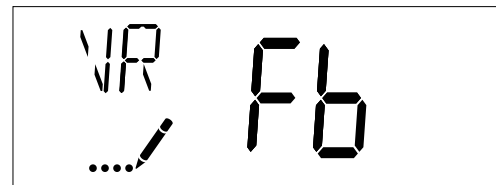

Figure 29



Figure 30

VO Range: 1 to Total Gallon Capacity

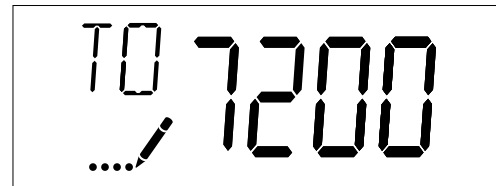

Figure 31

TO Range: 1 to 7200 (minutes)

18. End of Master Programming Mode

Press the Extra Cycle button to save all settings and exit Master Programming Mode.

VIEWING DIAGNOSTIC DATA

The SXT control records and maintains diagnostic data to assist with servicing and troubleshooting the water treatment system.

Abbreviation	Parameter	Description
FR	Flow Rate	Displays the current outlet flow rate.
PF	Peak Flow Rate	Displays the highest flow rate measured since last regeneration.
HR	Hours in Service	Displays the total hours that the unit has been in service since last regeneration.
VU	Volume Used	Displays the total volume of water treated by the unit since last regeneration.
RC	Reserve Capacity	Displays the system's reserve capacity calculated from the system capacity, feed water hardness, and safety factor.
TV	Totalizer Volume	Displays the total volume of water used by the unit since last installation or last reset.
SV	Software Version	Displays the software version installed on the controller.

NOTE: Some items may not be shown depending on control configuration. The control will discard any changes and exit the Diagnostics View if a button is not pressed for 60 seconds.

Diagnostics View Steps

1. Press the Up and Extra Cycle buttons for five seconds while in service.
2. Use this display to view the current Flow Rate. This option setting is identified by "FR" in the upper left corner of the screen.

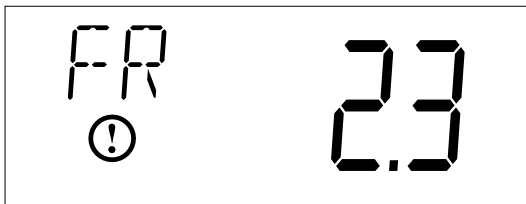

Figure 32

3. Press the Up button. Use this display to view the Peak Flow Rate since the last regeneration cycle. This option setting is identified by "PF" in the upper left corner of the screen.

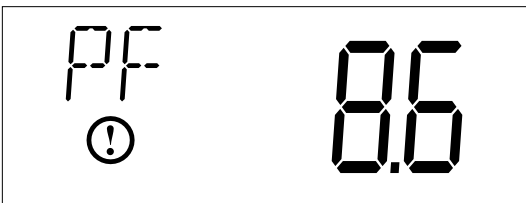

Figure 33

4. Press the Up button. Use this display to view the Hours in Service since the last regeneration cycle. This option setting is identified by "HR" in the upper left corner of the screen.

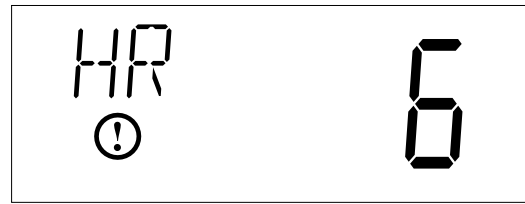

Figure 34

5. Press the Up button. Use this display to view the Volume Used since the last regeneration cycle. This option setting is identified by "VU" in the upper left corner of the screen.

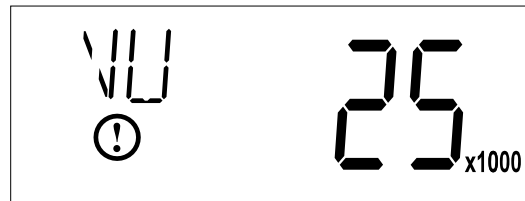

Figure 35

6. Press the Up button. Use this display to view the Reserve Capacity. This option setting is identified by "RC" in the upper left corner of the screen.



Figure 36

7. Press the Up button. Use this display to view the Total Volume data. This option is identified by "TV" in the upper left corner of the screen.

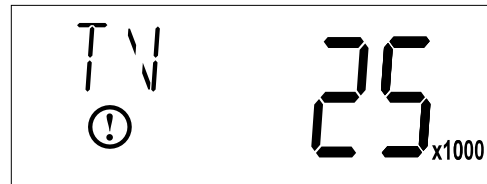

8. Press the Up button. Use this display to view the Software Version. This option setting is identified by "SV" in the upper left corner of the screen.

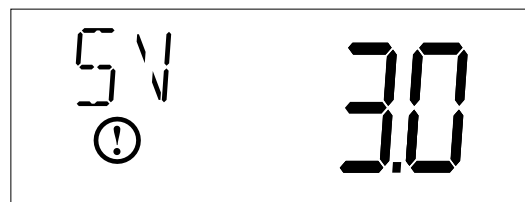

Figure 37

9. Press the Extra Cycle button to end Diagnostic Programming Mode.

5810 CONTROL VALVE ASSEMBLY

Item No.	QTY	Part No.	Description
1	1	581008-001	5810, SOF, DNF, M14, XTR2, 12-DC, CW 00-, .12, LES, NA2, 1600, SOFT
		581008-002	5810, SOF, UPF, M14, XTR2, 12-DC, CW 00-, .12, LES, NA2, 1600, SOFT
		581008-003	5810, FIL, DNF, CLK, XTR2, 12-DC, CW BWF, BWF, LES, NA2, BWF-, FILT

NOTE: Above part numbers DO NOT include the following parts.

Cover
 Bezel
 Distributor Adapter
 Bypass Assembly
 Connector Assembly
 Power Supply
 Flow Washer
 DLFC

See 5810/5812 accessories page for options.

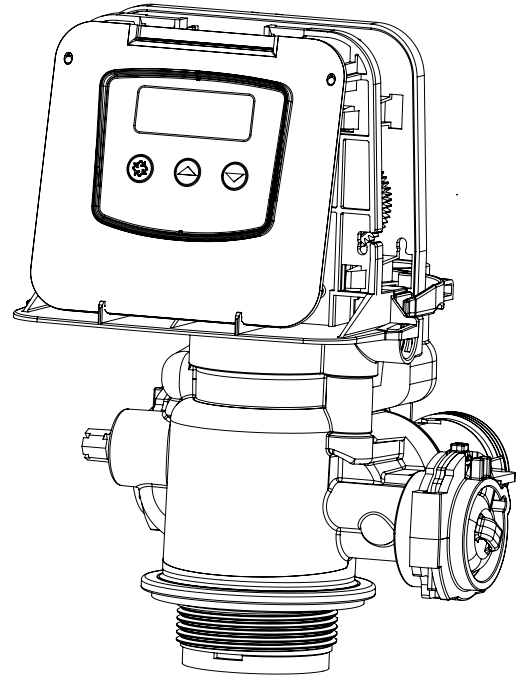

5812 CONTROL VALVE ASSEMBLY

Item No.	QTY	Part No.	Description
1	1	581208-001	5812, SOF, DNF, M14, XTR2, 12-DC, CW 00-, .12, LES, NA2, 1600, SOFT
		581208-002	5812, SOF, DNF, M14, XTR2, 12-DC, CW 5--., .5-, LES, NA4, 1600, SOFT
		581208-003	5812, SOF, UPF, M14, XTR2, 12-DC, CW 0--., .25, LES, NA2, 1600, SOFT
		581208-004	5812, SOF, UPF, M14, XTR2, 12-DC, CW 1--., .25, LES, NA4, 1600, SOFT
		581208-005	5812, FIL, DNF, CLK, XTR2, 12-DC, CW BWF, BWF, LES, NA2, BWF-, FILT
		581208-006	5812, FIL, DNF, CLK, XTR2, 12-DC, CW BWF, BWF, LES, NA4, BWF-, FILT

NOTE: Above part numbers DO NOT include the following parts.

Cover
 Bezel
 Distributor Adapter (except on 4" base models)
 Bypass Assembly
 Connector Assembly
 Power Supply
 Flow Washer
 DLFC

See 5810/5812 accessories page for options.

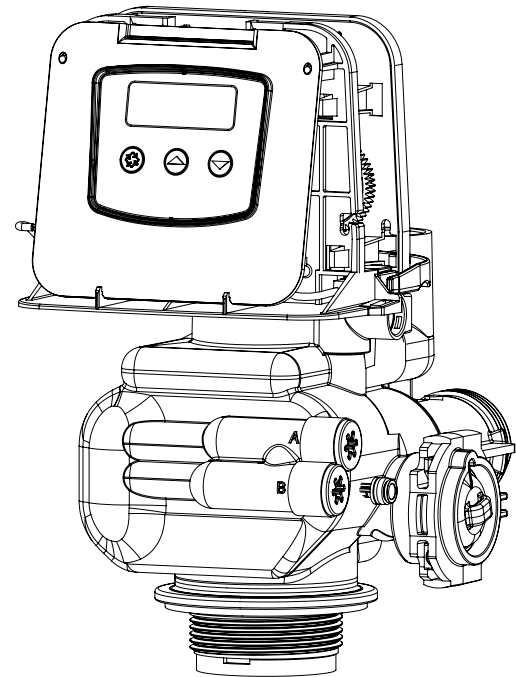

5810 CONTROL VALVE ASSEMBLY

Item No.	QTY	Part No.	Description
1	1	61961	Kit, Mounting, 5810/5812
2	1	61956-01	Kit, Piston, Seal, and Spacer, 5810, Downflow
		61956-02	Kit, Piston, Seal, and Spacer, 5810, Upflow
		61956-03	Kit, Piston, Seal, and Spacer, 5810, Filter
3	1	19791-01	Assy, Meter Cable
4	1	60016-01	Brine Valve
5	1	40947	Plug, Brine Valve
6	1	13302	O-ring, -014
7	1	61450-00	BLFC Assy 3/8", Blank
		61450-12	BLFC Assy 3/8", .12 GPM
		61450-25	BLFC Assy 3/8", .25 GPM
		61450-50	BLFC Assy 3/8", .50 GPM
		61450-100	BLFC Assy 3/8", 1.0 GPM
8	1	61451-00	BLFC Assy 1/2", Blank
		61451-12	BLFC Assy 1/2", .12 GPM
		61451-25	BLFC Assy 1/2", .25 GPM
		61451-50	BLFC Assy 1/2", .50 GPM
		61451-100	BLFC Assy 1/2", 1.0 GPM
9	1	41056	Nut Assy, 1/2"
10	2	40576-01	Clip, H, Plastic
11	1	61923-20	Cap, Regulated Injector, 20 PSI
		61923-30	Cap, Regulated Injector, 30 PSI
12	2	61958	Injector Cap Assy, w/O-ring
13	1	61454-0	Injector Assy, #0, Red
		61454-00	Injector Assy, #00, Violet
		61454-000	Injector Assy, 7000, #000, Brown
		61454-1	Injector Assy, #1, White
		61454-2	Injector Assy, #2, Blue
		61454-3	Injector Assy, #3, Yellow
		61454-4	Injector Assy, #4, Green
		61454-5	Injector Assy, #5, Gray
14	1	40945	Clip, Drain Retaining
15	1	61959	Injector Plug, w/O-rings
16	1	43719	Screen, Injector 5810/5812
17	1	40946	Clip, Brine Retaining
18	1	61983-01	Valve Body Assy, 5810
		61983-02	Valve Body Assy, 5810, Mixing
19	1	61919	Meter Assy, 1-1/4", 5810/5812
20	1	61419-02	Kit, 32mm Distributor, Adapter
21	1	61419-01	Kit, 1.315" Distributor, Adapter
22	1	61419	Kit, 1.05" Distributor Adapter
23	1	61455-00	DLFC 3/4", Elbow Blank
24	1	61456-00	DLFC 1", Straight Blank

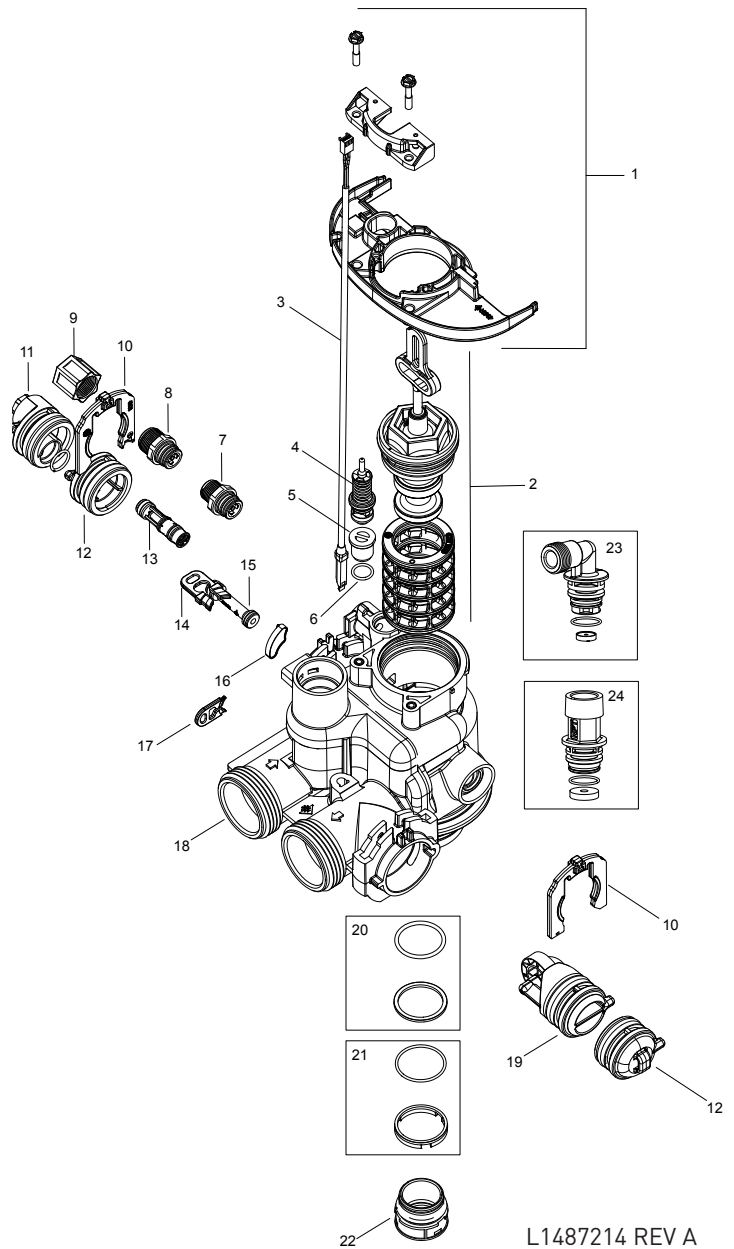

L1487214 REV A

NOTE: Install injector in hole "DF" and plug in hole "UF" for downflow units. In upflow units the injector plug and injector assembly are installed in reverse holes. In filter units, both injector holes are plugged with 61959. See illustration below.

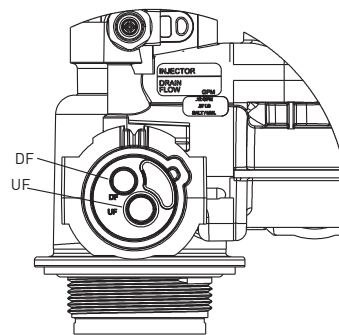

5812 CONTROL VALVE ASSEMBLY

Item No.	QTY	Part No.	Description
1	1	61961	Kit, Mounting, 5810/5812
2	1	61960-01	Kit, Piston, Seal, and Spacer, 5812, Downflow
		61960-02	Kit, Piston, Seal, and Spacer, 5812, Upflow
		61960-03	Kit, Piston, Seal, and Spacer, 5812, Filter
3	1	19791-01	Assy, Meter Cable
4	1	60016-01	Brine Valve
5	1	40947	Plug, Brine Valve
6	1	13302	O-ring, -014
7	1	61450-00	BLFC Assy 3/8", Blank
		61450-12	BLFC Assy 3/8", .12 GPM
		61450-25	BLFC Assy 3/8", .25 GPM
		61450-50	BLFC Assy 3/8", .50 GPM
		61450-100	BLFC Assy 3/8", 1.0 GPM
8	1	61451-00	BLFC Assy 1/2", Blank
		61451-12	BLFC Assy 1/2", .12 GPM
		61451-25	BLFC Assy 1/2", .25 GPM
		61451-50	BLFC Assy 1/2", .50 GPM
		61451-100	BLFC Assy 1/2", 1.0 GPM
9	1	41056	Nut Assy, 1/2"
10	2	40576-01	Clip, H, Plastic
11	1	61923-20	Cap, Regulated Injector, 20 PSI
		61923-30	Cap, Regulated Injector, 30 PSI
12	1	61454-0	Injector Assy, #0, Red
		61454-00	Injector Assy, #00, Violet
		61454-000	Injector Assy, 7000, #000, Brown
		61454-1	Injector Assy, #1, White
		61454-2	Injector Assy, #2, Blue
		61454-3	Injector Assy, #3, Yellow
		61454-4	Injector Assy, #4, Green
		61454-5	Injector Assy, #5, Gray
13	2	61959	Injector Plug, w/O-rings
14	1	43719	Screen, Injector 5810/5812
15	1	40946	Clip, Brine Retaining
16	1	61984-01	Valve Body Assy, 5812, 2-1/2" Base
		61984-11	Valve Body Assy, 5812, 4" Base*
		61984-02	Valve Body Assy, 5812, 2-1/2" Base, Mixing
17	1	43596	Clip, Drain Retaining
18	1	61919	Meter Assy, 1-1/4", 5810/5812
19	1	61419-01	Kit, 1.315" Distributor Adapter
20	1	61419-02	Kit, 32mm Distributor Adapter
21	1	61419	Kit, 1.05" Distributor Adapter
22	1	13577-01	O-ring, -226, 560CD
23	1	41747	Retainer, Distributor, 1.5"
24	2	61958	Injector Cap Assy, w/O-ring
25	2	1000269	Cap Assembly, Blank

*Includes items 24 and 25. Each valve body is installed with adapters for a 4" tank base and packaged with distributor adapter kits for 1.5" distributors [items 24 and 25].

**See "5812 Valve Accessories"

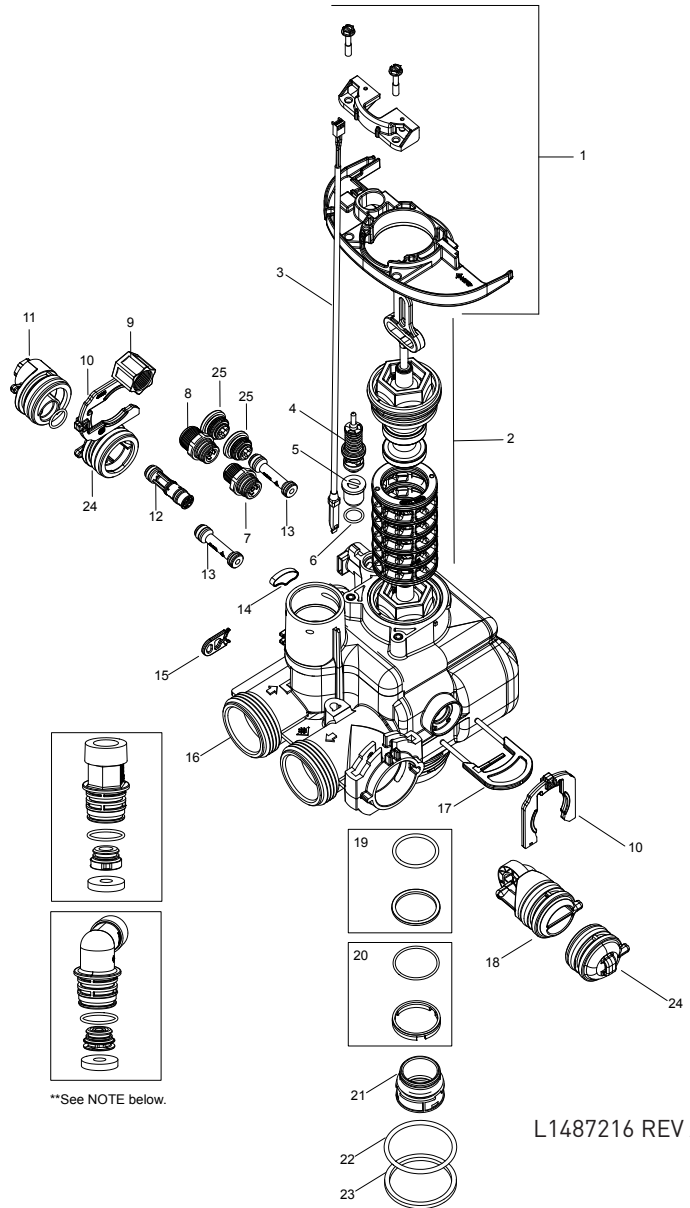

L1487216 REV A

NOTE: Install injector in hole "DF" and plug in hole "UF" for downflow units. In upflow units the plug and injector are installed in reverse holes. In filter units, both injector holes are plugged with 61959. See illustration below.

NOTE: Install plug in hole "A" for units that allow hard water to flow during regeneration. For no hard water bypass (downflow only), install plug in hole "B". See illustration below.

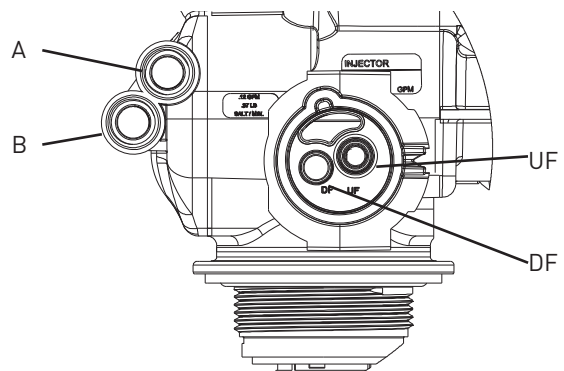

5810/5812 VALVE ACCESSORIES

Covers

- 43261 Cover, 5800
- 43715 Cover, 5800, Lower
- 61994 Cover Assy, Environmental 5810/5812
Gray

Bezels

- 43262-00 Bezel, Blue
- 43262-01 Bezel, Black
- 43262-02 Bezel, Silver

Adapter Kits

- 61419 Kit, 1.05" Distributor, Adapter
- 61419-01 Kit, 1.315" Distributor, Adapter
- 61419-02 Kit, 32mm Distributor, Adapter

Bypasses

- 43644 Bypass Assembly, 1.25", 5810/12

Connector Assemblies

- 61991-01 Connector Assy, 1" NPT
- 61991-02 Connector Assy, 1" BSP
- 61991-03 Connector Assy, 1 1/4" NPT
- 61991-04 Connector Assy, 1 1/4" BSP
- 61991-05 Connector Assy, 3/4"-1" Sweat
- 61991-06 Connector Assy, 1"-1 1/4" Sweat
- 61991-07 Connector Assy, 1 1/4" - 1 1/2" Sweat
- 61991-08 Connector Assy, 1 1/2" NPT
- 61991-09 Connector Assy, 1 1/2" BSP
- 61991-10 Connector Assy, 3/4" & 1" CPVC
- 61991-11 Connector Assy, 1 1/4" & 1 1/2" CPVC

Connector Elbow

- 61992 Connector Elbow Assembly

Power Supplies

- 44161 Power Supply, US, 12V DC 3M, 2A
- 44162 Power Supply, INTL, 12V DC 3M, 2A

Washers

- 19149 Washer, Flow, 1.7 GPM (5810 Only)
- 12087 Washer, Flow, 2.0 GPM (5810 Only)
- 12088 Washer, Flow, 2.4 GPM (5810 Only)
- 12089 Washer, Flow, 3.0 GPM
- 12090 Washer, Flow, 3.5 GPM
- 12091 Washer, Flow, 4.0 GPM
- 19147 Washer, Flow, 4.5 GPM
- 12092 Washer, Flow, 5.0 GPM
- 17814 Washer, Flow, 6.0 GPM
- 12408 Washer, Flow, 7.0 GPM
- 17943 Washer, Flow, 8.0 GPM
- 17944 Washer, Flow, 9.0 GPM
- 16529 Washer, Flow, 10.0 GPM
- 16735 Washer, Flow, 12.0 GPM
- 16736 Washer, Flow, 15.0 GPM
- 16528 Washer, Flow, 20.0 GPM
- 16737 Washer, Flow, 25.0 GPM
- 43736 Washer, Flow, 30.0 GPM (5812 Only)
- 43737 Washer, Flow, 35.0 GPM (5812 Only)
- 43738 Washer, Flow, 40.0 GPM (5812 Only)
- 43739 Washer, Flow, 45.0 GPM (5812 Only)

DLFC - 5810 ONLY

- 61455-00 DLFC, 3/4", Elbow, NPT, Blank,
For 0.6-7.0 GPM Washers
- 61456-00 DLFC Assy, 1", Straight, NPT,
For 0.8 - 25 GPM Washers
- 62088-00 DLFC Assy, 1", Straight, NPT,
Blank, For 8.0 - 25 GPM Washers
- 61456-30 DLFC Assy, 1", 30 GPM

DLFC - 5812 ONLY

- 61971-00 DLFC, 1" NPT, Blank, Elbow, 5812
For 0.6-35.0 GPM Washers
- 61974-00 DLFC, 1" BSP, Blank, Elbow, 5812
For 0.6-35.0 GPM Washers
- 61977-00 DLFC, 1 1/4" NPT, Blank, Straight, 5812
For 0.6-45.0 GPM Washers
- 61980-00 DLFC, 1 1/4" BSP, Blank, Straight, 5812
For 0.6-45.0 GPM Washers

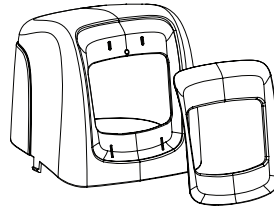

COVER, BEZEL

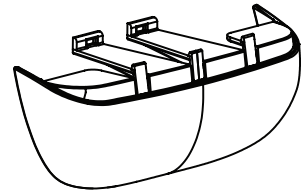

COVER, LOWER

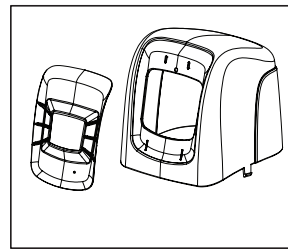

COVER, ENVIRONMENTAL



ADAPTER KITS

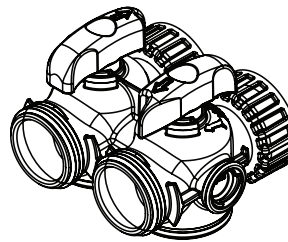

BYPASS ASSY

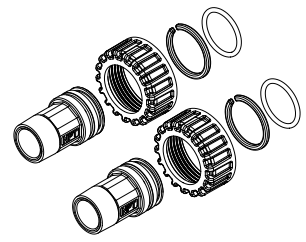

CONNECTOR ASSY, STRAIGHT

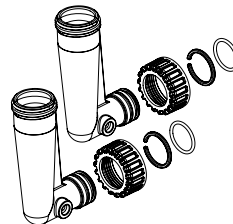

CONNECTOR ASS, ELBOW

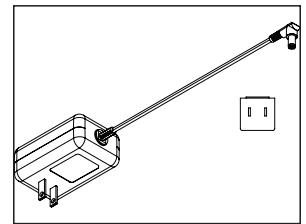

POWER SUPPLIES



WASHERS

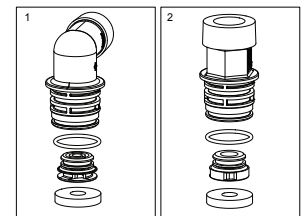

DLFC

5810/5812 VALVE ASSEMBLIES

BLFC

61450-00	BLFC, 3/8", Blank
61450-12	BLFC, 3/8", 0.125 GPM
61450-25	BLFC, 3/8", 0.25 GPM
61450-50	BLFC, 3/8", 0.50 GPM
61450-100	BLFC, 3/8", 1.0 GPM
61451-00	BLFC, 1/2", Blank
61451-12	BLFC, 1/2", 0.125 GPM
61451-25	BLFC, 1/2", 0.25 GPM
61451-50	BLFC, 1/2", 0.50 GPM
61451-100	BLFC, 1/2", 1.0 GPM

Injector Assemblies

61454-0	Injector Assy, #0 RED (12" & 13" Tank)
61454-00	Injector Assy, #00 VIOLET (9" & 10" Tank)
61454-000	Injector Assy, #000 BROWN (8" Tank)
61454-1	Injector Assy, #1 WHITE (14" & 16" Tank)
61454-2	Injector Assy, #2 BLUE (18" Tank)
61454-3	Injector Assy, #3 YELLOW (20" Tank)
61454-4	Injector Assy, #4 GREEN (21" Tank)
61454-5	Injector Assy, #5 GRAY (24" Tank)

Injector Caps

61923-20	Cap, Regulated Injector, 20 PSI
61923-30	Cap, Regulated Injector, 30 PSI
61958	Injector Cap w/o-ring

Powerheads

61957	5800/5810/5812 Powerhead. Less Timer, Less Power Supply
-------	-------	--

Timers

62076	Timer Assy, SXT, 5800
-------	-------	-----------------------

Meters

61919	Meter Assy, 1-1/4", 5810/5812
-------	-------	-------------------------------

Meter Cables

19791-01	Meter Cable Assy, Turbine/SXT
----------	-------	-------------------------------

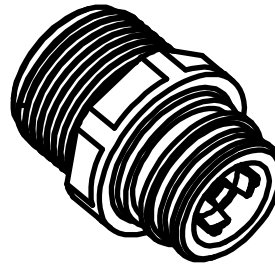

BLFC (3/8")

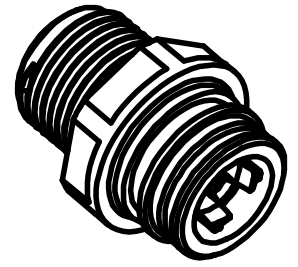

BLFC (1/2")

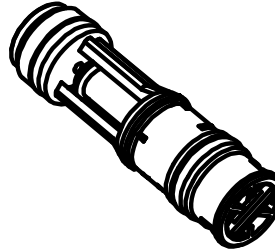

INJECTOR ASSY

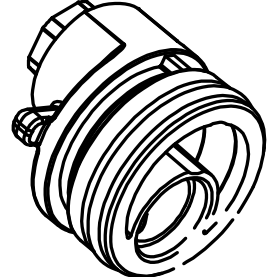

CAP, REGULATED INJECTOR

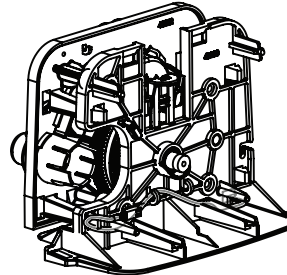

POWERHEAD

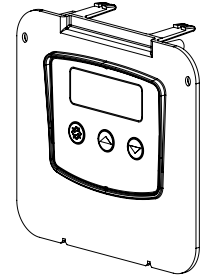

TIMER ASSY, SXT

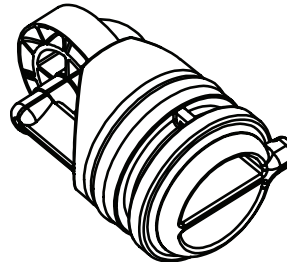

METER ASSY



METER CABLE ASSY

SAFETY BRINE VALVE

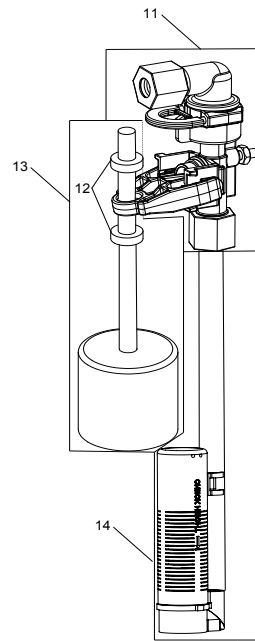
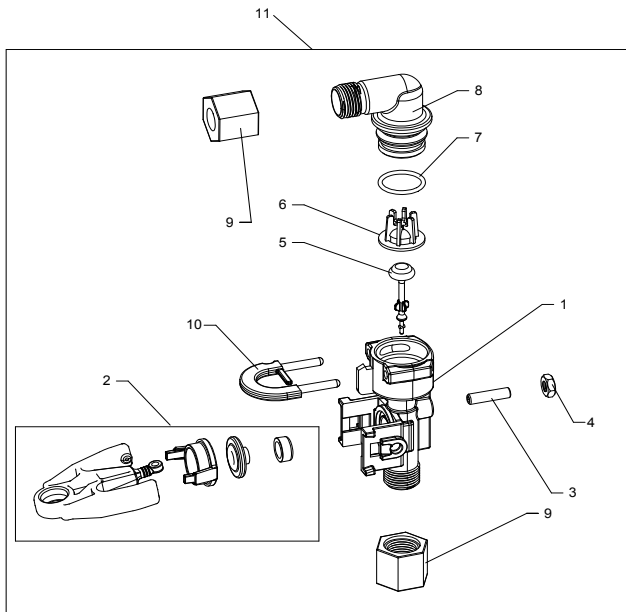

42112 Rev A

Item No.	QTY	Part No.	Description
1	1	19645	Body, Safety Brine Valve, 2310
2	1	19803	Safety Brine Valve Assy
3	1	19804	Screw, Sckt Hd, Set, 10-24 x 0.75
4	1	19805	Nut, Hex, 10-24, Nylon Black
5	1	19652-01	Poppet Assy, SBV w/O-ring
6	1	19649	Flow Dispenser
7	1	11183	O-ring, -017
8	1	19647	Elbow, Safety Brine Valve
9	2	19625	Nut Assy, 3/8" Plastic
10	1	18312	Retainer, Drain
11	1	60014	Safety Brine Valve Assy, 2310
12	2	10150	Grommet, 0.30 Dia
13	1	60068-10.5	Float Assy, 2310, w/10.5" Rod
		60068-11.5	Float Assy, 2310, w/11.5" Rod
		60068-20	Float Assy, 2310, w/20" Rod
		60068-30	Float Assy, 2310, w/30" Rod
14	1	60002-11.38	Air Check, #500, 11.38" Long
		60002-27	Air Check, #500, 27" Long
		60002-32	Air Check, #500, 32" Long
		60002-34	Air Check, #500, 34" Long
		60002-36	Air Check, #500, 36" Long
		60002-48	Air Check, #500, 48" Long
		60002-26.25	Air Check, #500, 26.25" Long
		60002-33.25	Air Check, #500, 33.25" Long

TROUBLESHOOTING

Error Codes

NOTE: Error codes appear on the In Service display.

Error Code	Error Type	Cause	Reset and Recovery
---0	Motor Stall /Cam Sense Error	No state changes in the optical sensor are detected for six seconds.	<p>Unplug the unit and plug back in. Allow the control to attempt to find position again.</p> <p>Verify the optical sensor is in place with the wires connected to the circuit board. Verify the motor and drive train components are in good condition and assembled properly. Check the valve and verify that the piston travels freely. Replace/reassemble the various components as necessary.</p> <p>Plug the unit back in and observe its behavior. If the error reoccurs, unplug the unit, put it into bypass and contact technical support.</p>
---1	Motor Run-On Error /Cycle Sense Error	An undesired optical sensor state change occurred.	Non-critical error. Extra optical sensor pulse detected. Press any button to clear the error. Press extra cycle button to advance motor to clear error.
---2	Regen Failure	The system has not regenerated for more than 99 days (or 7 days if the Control Type has been set to Day-of-Week).	<p>Perform a Manual Regeneration to reset the error code.</p> <p>If the system is metered, verify that it is measuring flow by running service water and watching for the flow indicator on the display. If the unit does not measure flow, verify that the meter cable is connected properly and that the meter is functioning properly.</p> <p>Enter Master Programming Mode and verify that the unit is configured properly, For the valve configuration. Check that the correct system capacity has been selected, that the day override is set properly, and that meter is identified correctly. If the unit is configured as a Day-of-Week system, verify that at least one day is set ON. Correct the setting as necessary.</p>
---3	Memory Error	Control board memory failure.	Perform a Master Reset and reconfigure the system via Master Programming Mode. After reconfiguring the system, step the valve through a manual regeneration. If error continues, call technical support.
---4	Fail Safe Error	Valve has failed to find position in one minute.	Unplug the unit and plug it back in. If error continues, call technical support.

WATER CONDITIONER FLOW DIAGRAMS

5810 Upflow

1. SERVICE POSITION

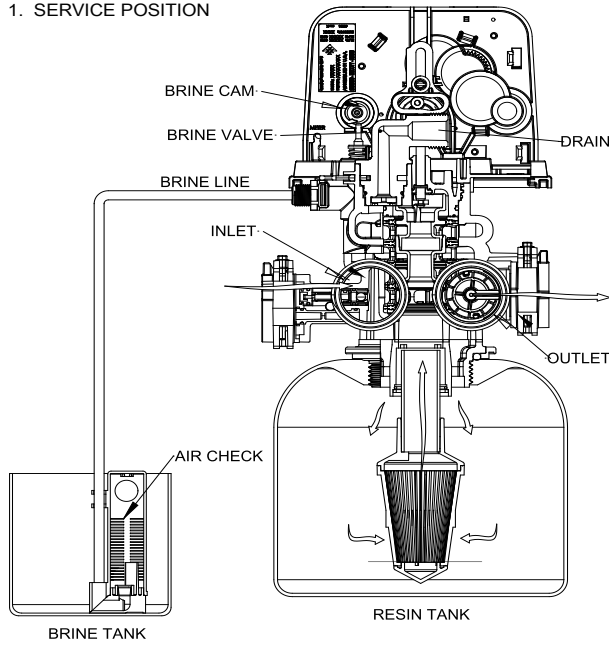

2. BRINE/SLOW RINSE POSITION

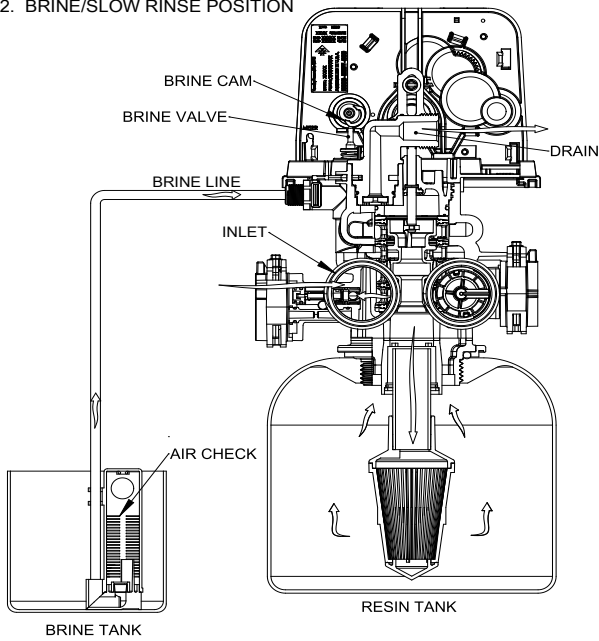

3. BACKWASH POSITION

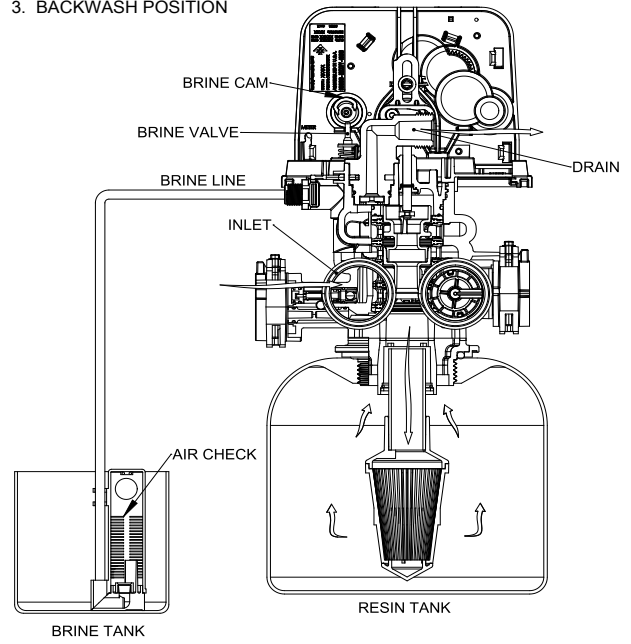

4. RAPID RINSE POSITION

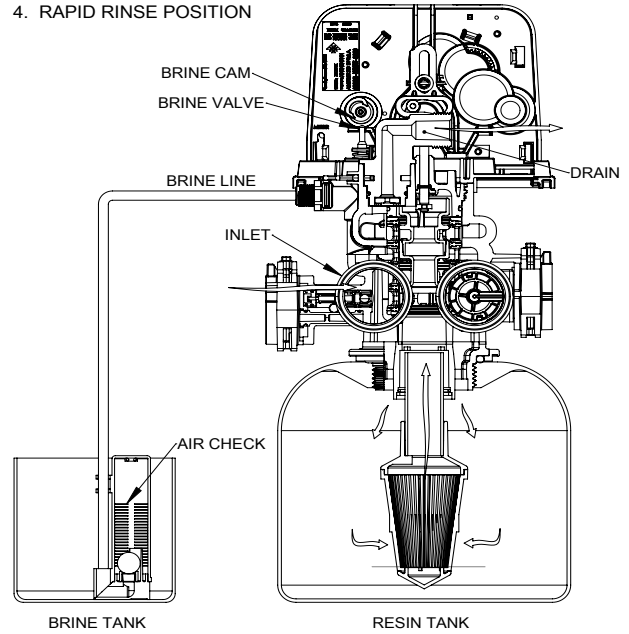

5. BRINE TANK REFILL POSITION

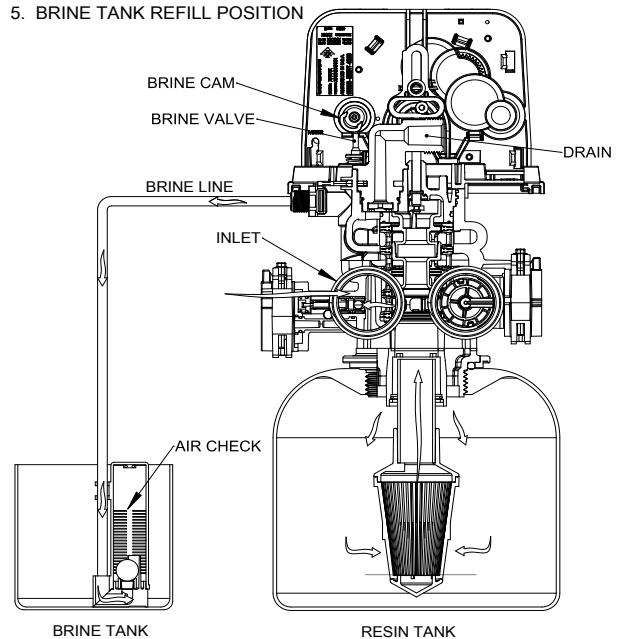

WATER CONDITIONER FLOW DIAGRAMS

continued

5810 Downflow

1. SERVICE POSITION

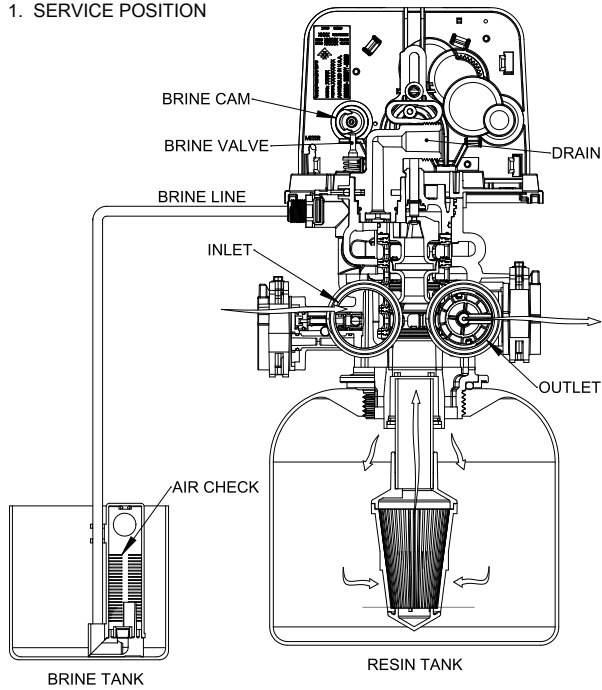

2. BACKWASH POSITION

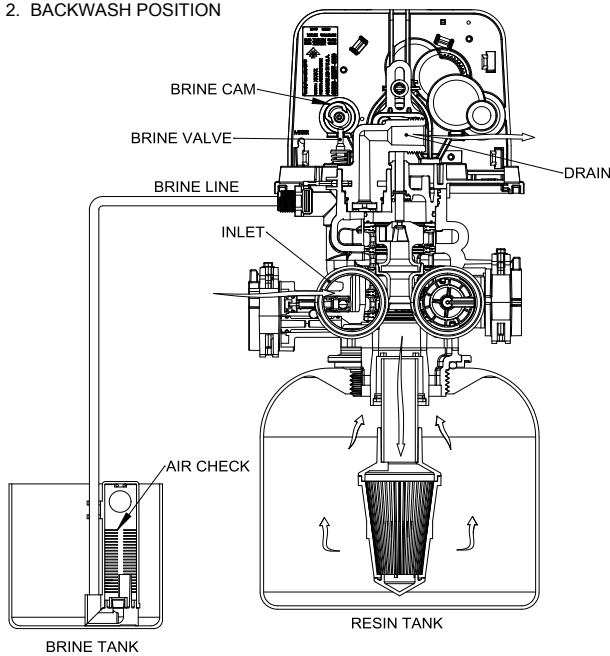

3. BRINE/SLOW RINSE POSITION

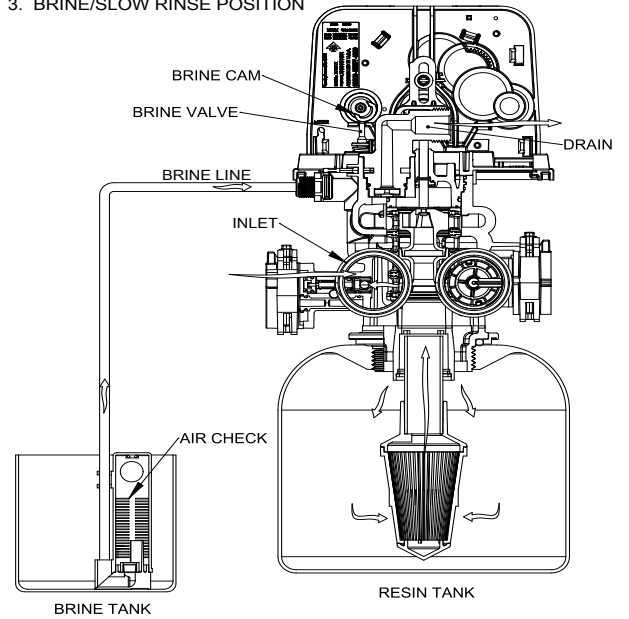

4. RAPID RINSE POSITION

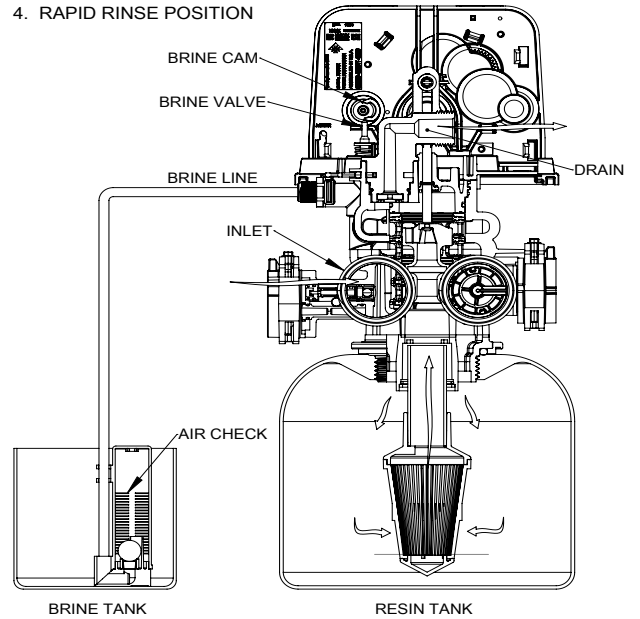

5. BRINE TANK REFILL POSITION

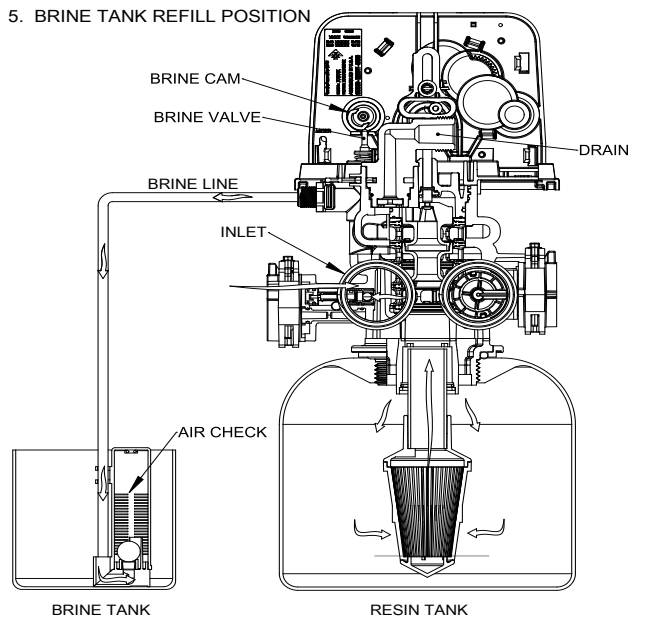

WATER CONDITIONER FLOW DIAGRAMS

5812 Upflow

1. SERVICE POSITION

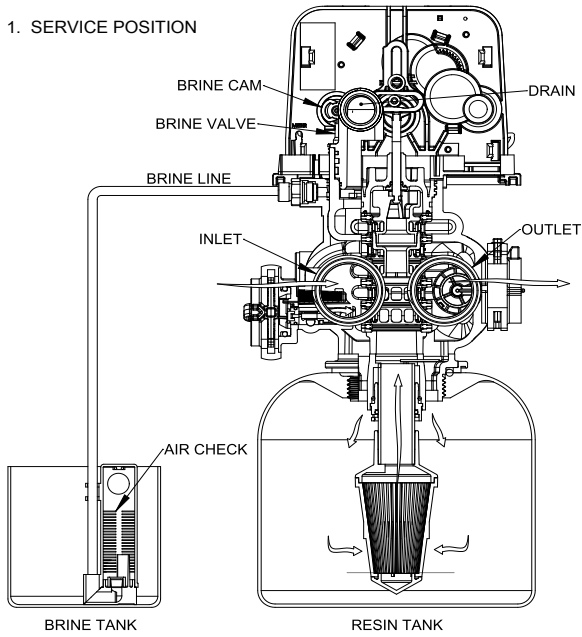

2. BRINE/SLOW RINSE POSITION

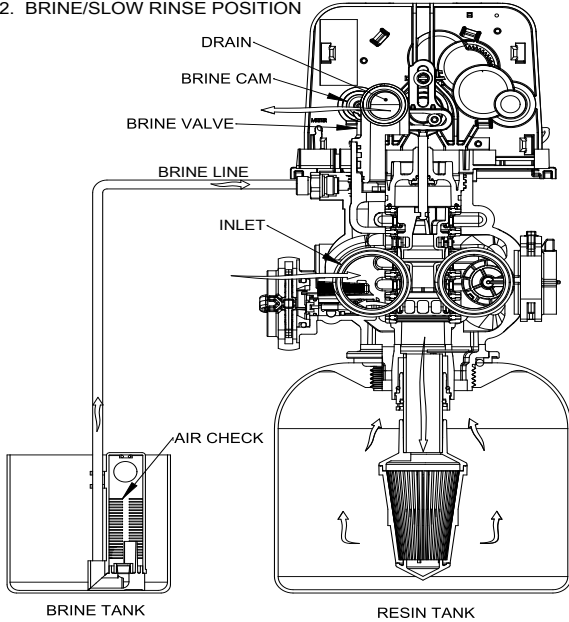

3. BACKWASH POSITION

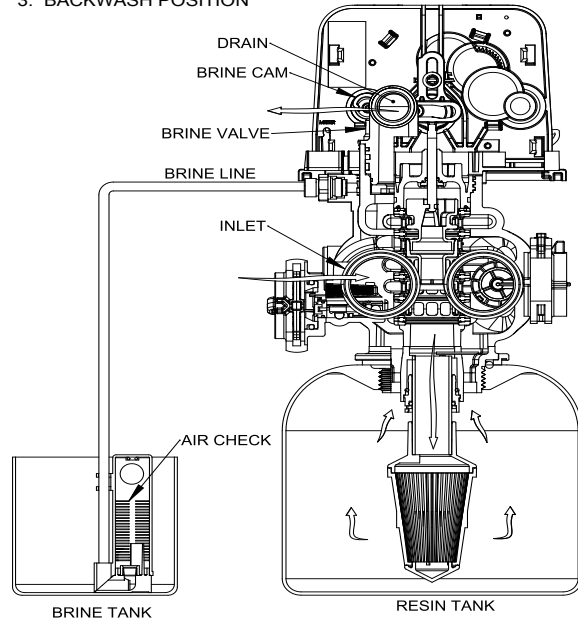

4. RAPID RINSE POSITION

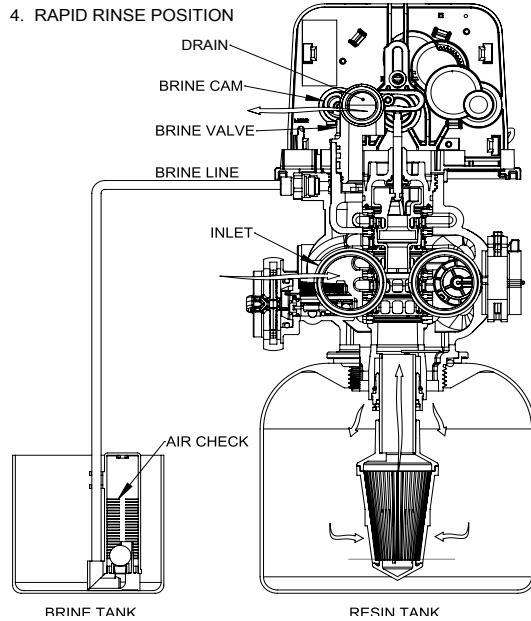

5. BRINE TANK REFILL POSITION

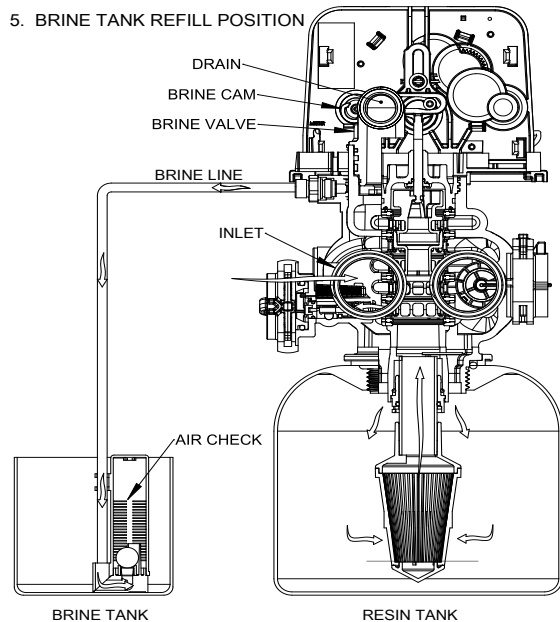

WATER CONDITIONER FLOW DIAGRAMS

continued

5812 Downflow

1. SERVICE POSITION

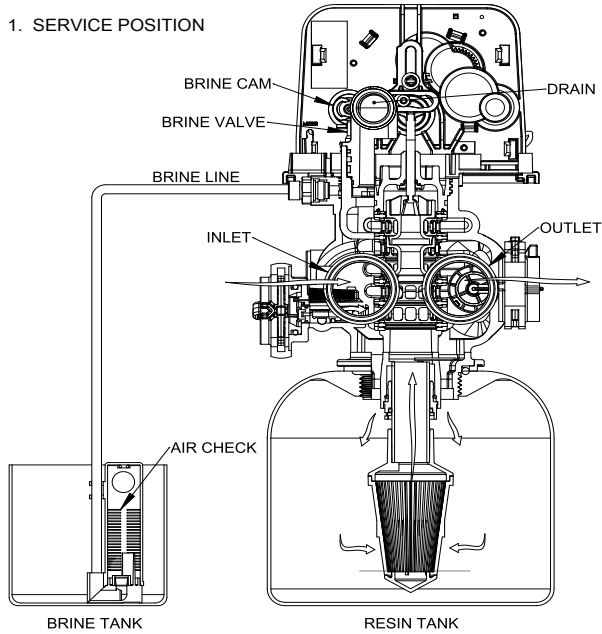

2. BACKWASH POSITION

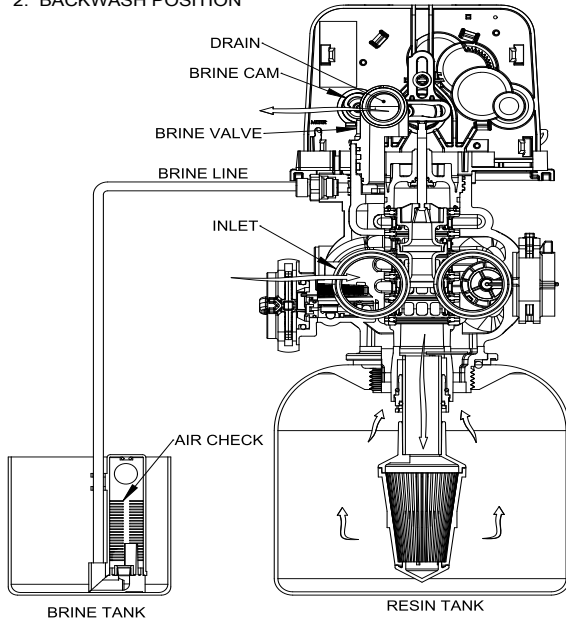

3. BRINE/SLOW RINSE POSITION

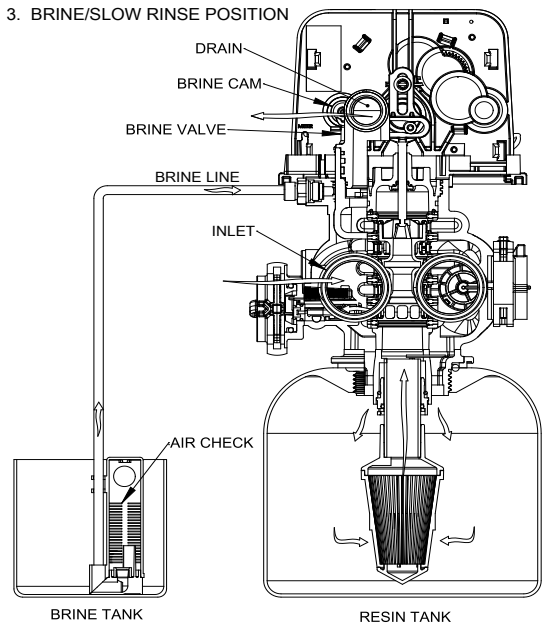

4. RAPID RINSE POSITION

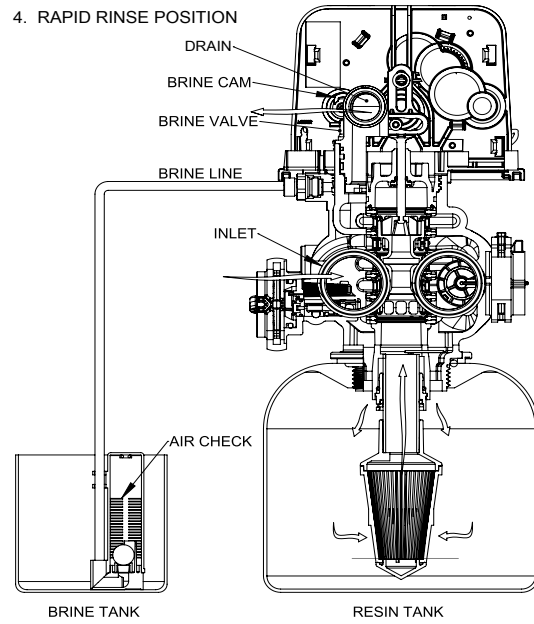

5. BRINE TANK REFILL POSITION

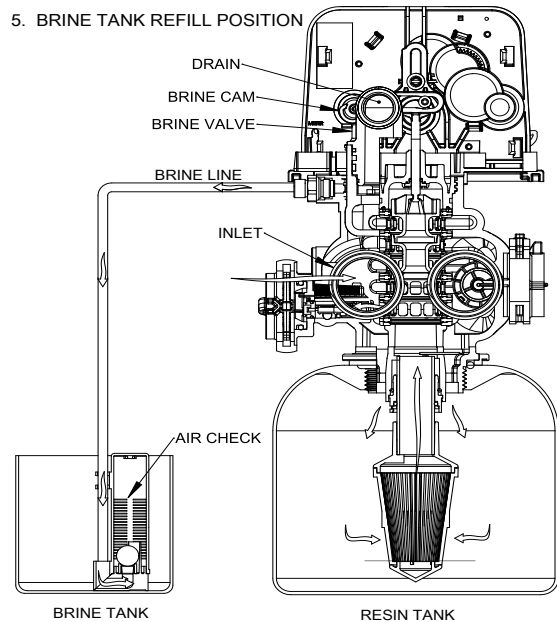

5810 DIMENSIONAL DRAWINGS

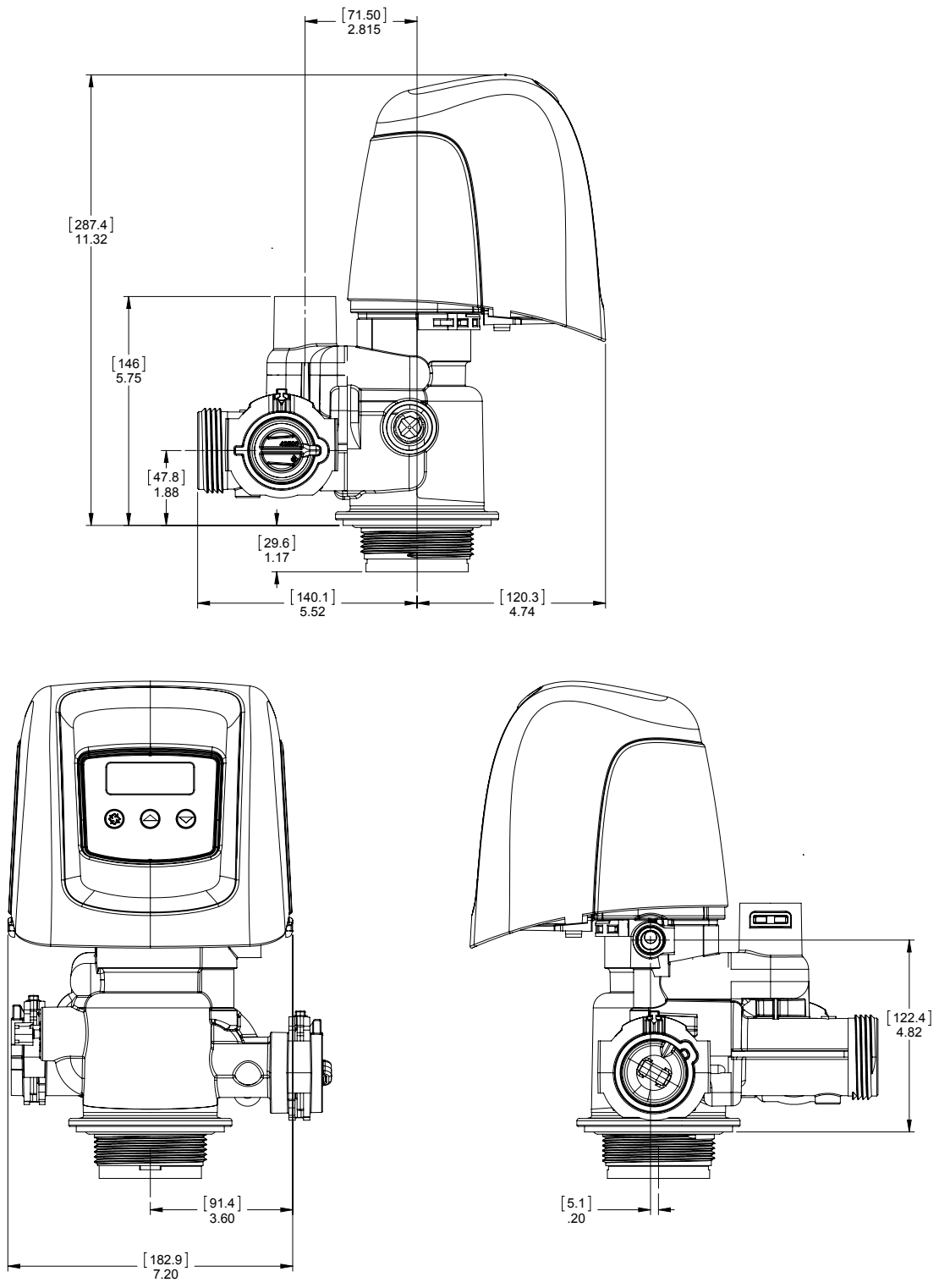

61500-5810LNE REV A

5812 DIMENSIONAL DRAWINGS

5812 2.5" BASE

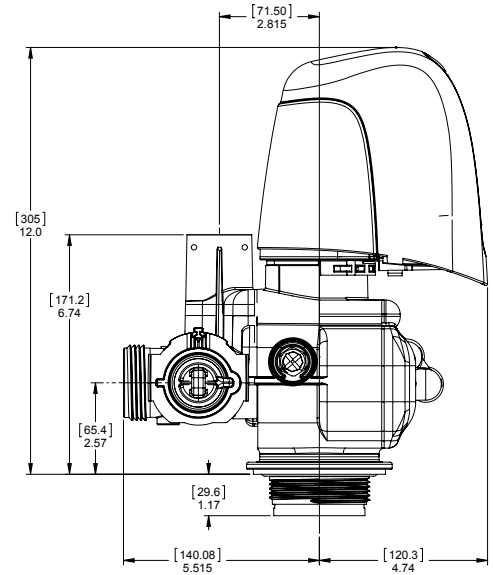
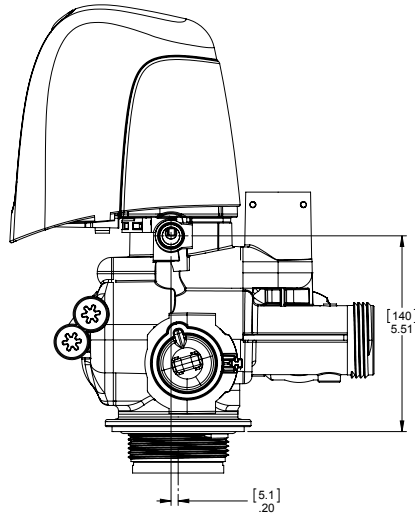
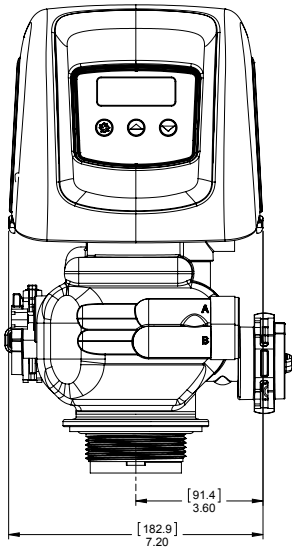

5812 4" BASE

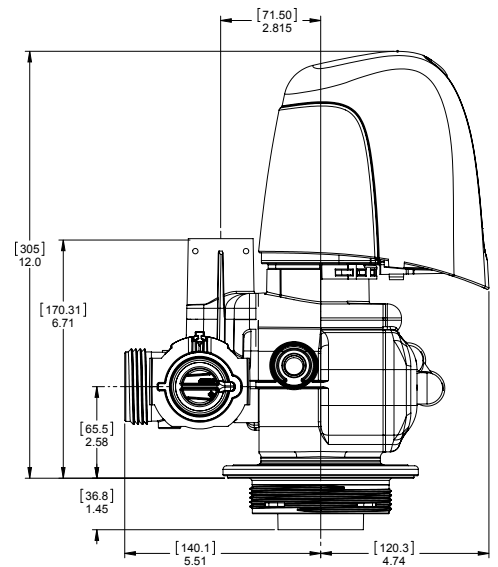
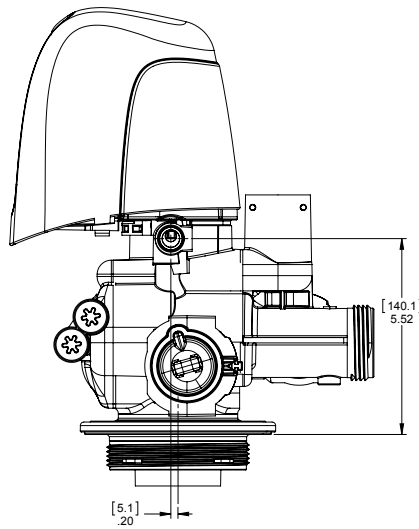
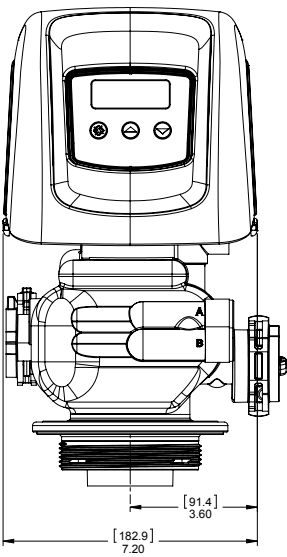

61500-5812LNE REV A

SXT WIRING DIAGRAM

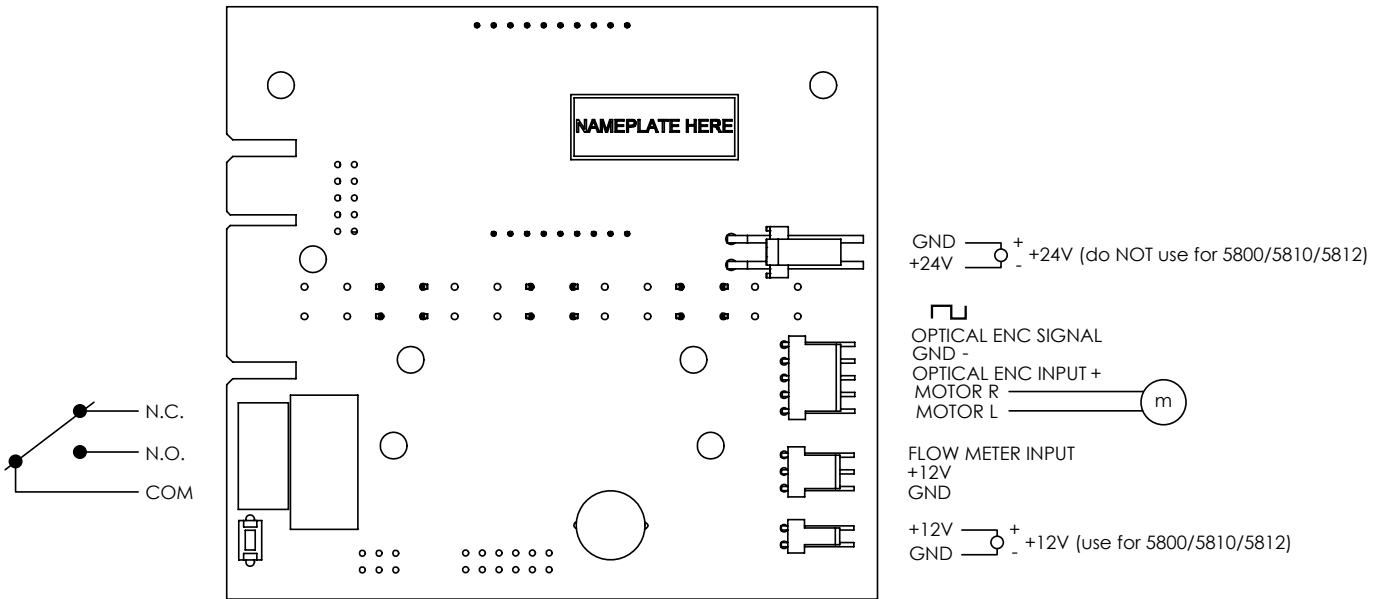

44060U REV G

INJECTOR FLOW DATA

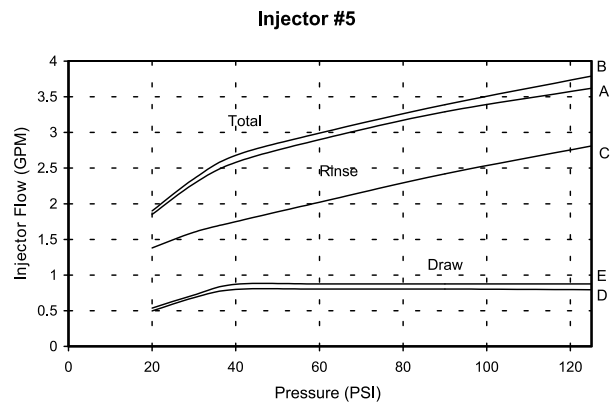
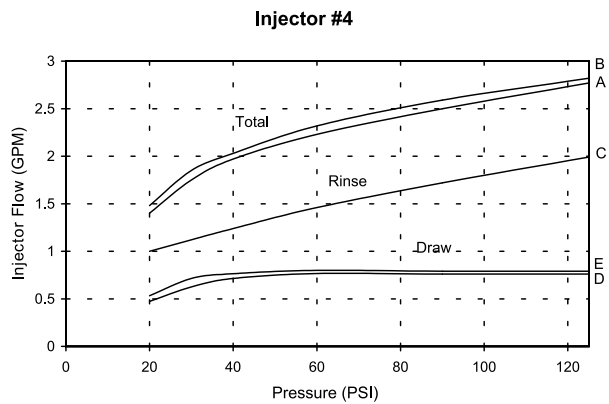
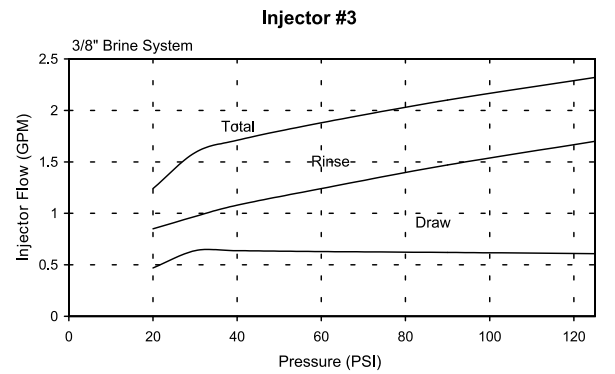
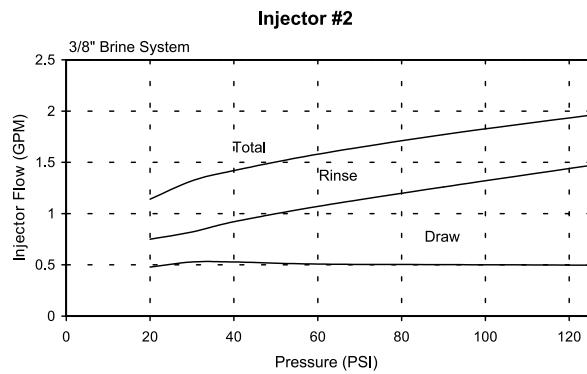
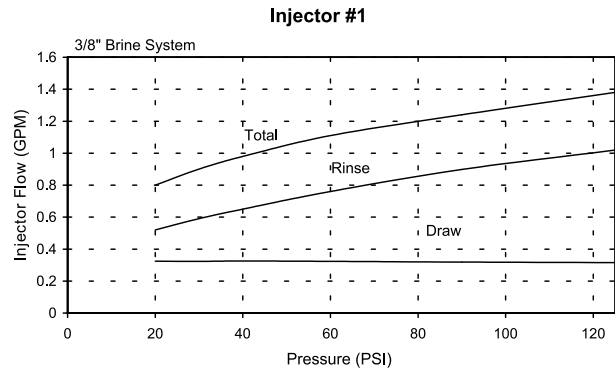
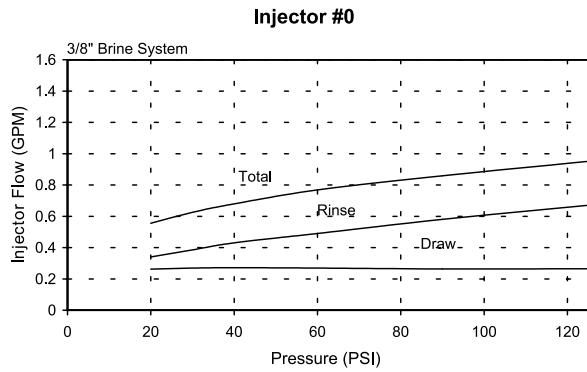
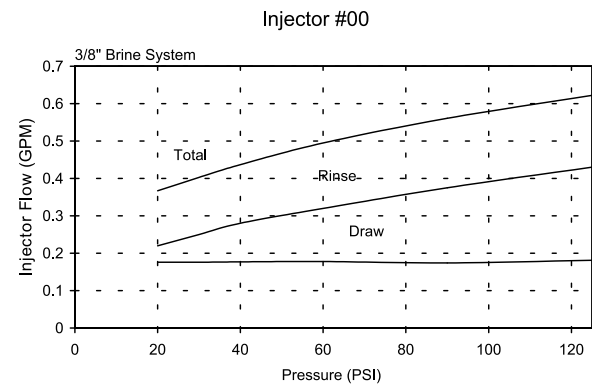
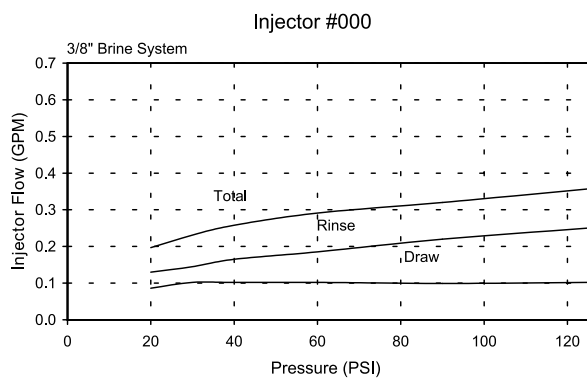

A) Total Flow, 3/8" Brine System B) Total Flow, 1/2" Brine Line C) Rinse D) Brine Draw, 3/8" Brine System E) Brine Draw, 1/2" Brine Line

NOTE: All data taken with 2310 Safety Brine Valve and 500 Air Check

TR18755 REV B

TYPICAL RESIDENTIAL SYSTEM PLUMBING

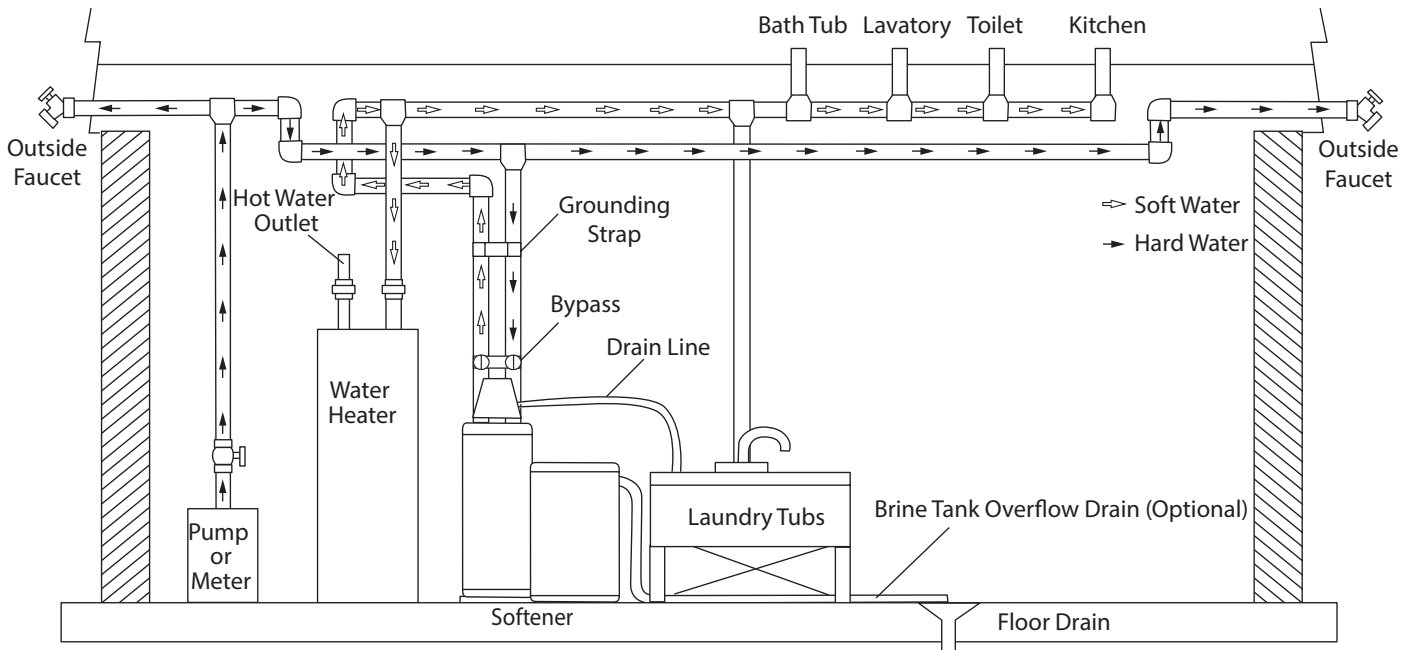
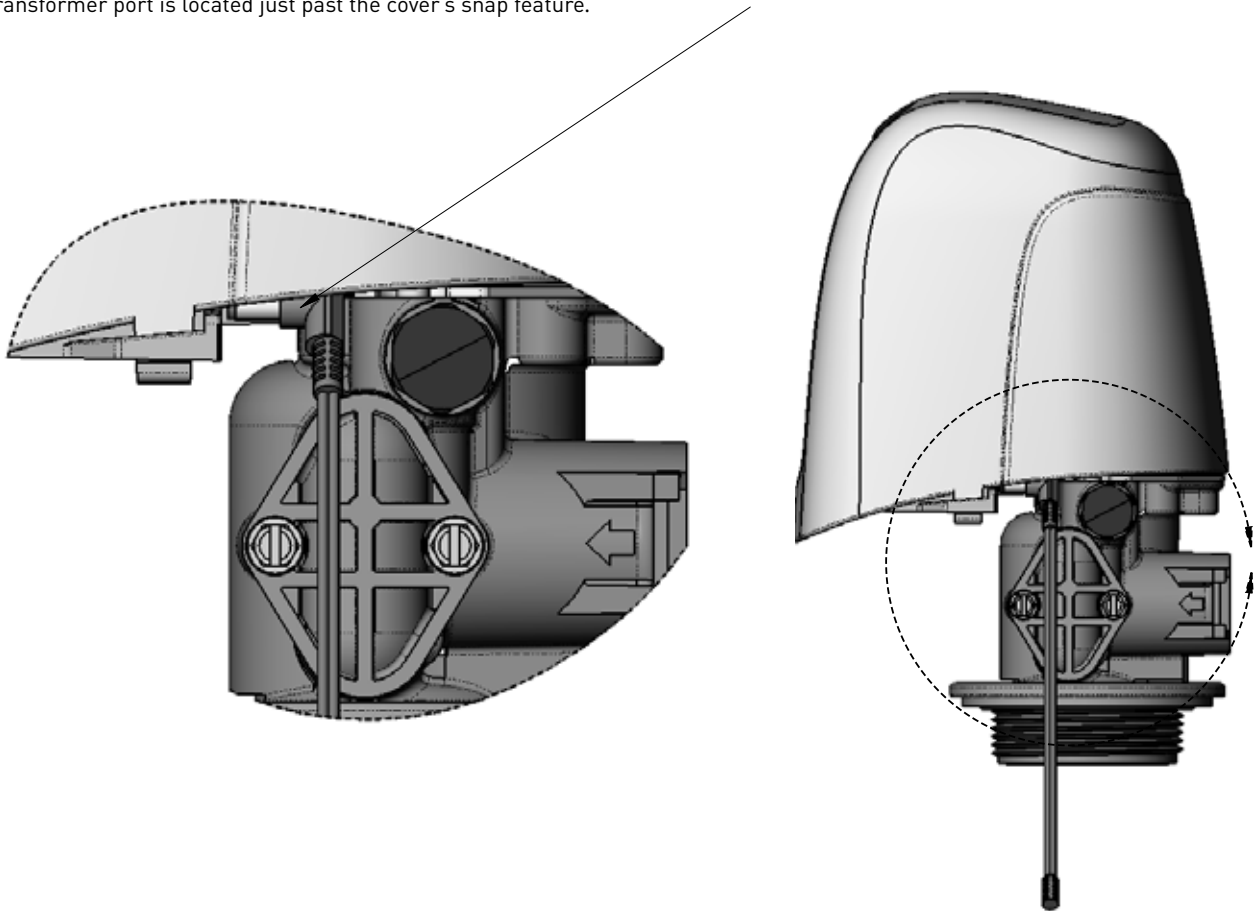

Figure 38 Softened Water Flow

TRANSFORMER PORT LOCATION

Transformer port location (plugging in transformer)

When looking at valve from front, reach around back under cover on right hand side. Transformer port is located just past the cover's snap feature.



44288 REV A

For Fleck[®] Product Warranties visit:
Fleck para las garantías de los productos visite: } waterpurification.pentair.com
Pour Fleck garanties produit visitez le site :



5730 NORTH GLEN PARK ROAD, MILWAUKEE, WI 53209
P: 262.238.4400 | WATERPURIFICATION.PENTAIR.COM
CUSTOMER CARE: 800.279.9404 | tech-support@pentair.com

[®]For a detailed list of where Pentair trademarks are registered, please visit waterpurification.pentair.com.
Pentair trademarks and logos are owned by Pentair plc or its affiliates.

Third party registered and unregistered trademarks and logos are the property of their respective owners.

44019 REV G AU17 ©2017 Pentair Residential Filtration, LLC. All Rights Reserved.